



OFFICIAL
WECHAT



OFFICIAL
FACEBOOK



OFFICIAL
WEBSITE



OFFICIAL
ALIBABA

希望此书可以一步步完善并成为经典，如有不对之处，望广大用户、代理、供应商、同行能及时指正，谢谢！

Hope this catalogue step by step could to be the classical sewing machine book, doesn't matter you are our partners or distributors or end users or suppliers or competitors, please help us find mistakes, thank you very much!

Distributor:



VMA SEWING



台州市唯美缝纫机有限公司

CATALOGUE **2023**

The specification and/or appearance of the equipment described in this catalogue are subject to change without previous notice because of modification.



V is Various
M is Machine
A is Advanced

 Provide  Complete  Sewing  Solution



Every factory will say "we are good quality", but only in TaiZhou there are more than 500 factories for sewing machine and more than 500 factories for spare parts, which is the real good quality you need?

VMA focus on providing customers with middle to high quality sewing machines, we have our own factory producing high-level products, and already cooperated with 250 other special machines' sewing factories in past 10 years.

Our customers spread in 50 different countries over the world, with sufficient experience to tell different quality level, we can recommend and provide you with correct and good quality sewing machines, to make sure you obtain trust worthy products at a reasonable price.

Please join us and continue grow up together with us!

MISSION:

Group up together with our product users, distributor partners ,vma team, and suppliers

VISION:

VMA to be a trustable famous sewing machine brand

VALUES:

Brand development is driven by the efforts of distributor partners, suppliers and team members, we stitck together when facing difficulties, we enjoy together when achieve success.



COMPANY IMAGE



● COMPANY



● PRODUCTION LINE



● INVENTORY



● INVENTORY



● CUTTING MACHINE PRODUCTION LINE



● EXCLUSIVE AGENT SHOP 1



● EXCLUSIVE AGENT SHOP 2



● EXCLUSIVE AGENT SHOP 3



● EXCLUSIVE AGENT SHOP 4



● EXCLUSIVE AGENT SHOP 5



● EXCLUSIVE AGENT SHOP 6

TAIZHOU VMA SEWING MACHINE CO.,LTD. Located in TaiZhou city Zhejiang province which provide good sewing machine, mainly for Lockstitch, overlock, interlock, special machines, heavy duty machines, cutting machines, etc., which has the ability to provide a full line sewing machines for the customers.

All of the spare parts used on our machine is first class in China, and with a restrict quality control rules, to guarantee only sent out the good sewing machine.

Also we give extra service for our distributors to collect other textile machines combine containers, together with distributors provide a full complete solution.



● PRIVATE EXHIBITION



● CISMA 2019



● CISMA 2017



● CISMA 2015

AGENT EXHIBITION



● SUCCESSFUL OEM CUSTOMER



● AGENT EXHIBITION

CATALOGUE



LOCKSTITCH

New electronic lockstitch	01	Long arm lockstitch	08
New direct drive lockstitch	02	Double needle lockstitch	09
Electronic lockstitch	03	Chain stitch	10
Direct drive & trimmer only lockstitch	04	Differential transportation lockstitch	11
Mechanical lockstitch	05	Upper differential	12
Needle feed lockstitch	06	Cylinder bed lockstitch series	13
Edge cutter lockstitch	07	Sweater use	14

OVERLOCK & INTERLOCK

5000rpm New overlock	15	Flat-seamer 4 needle 6 thread machine	21
Machine body heavy overlock	16	New interlock	22
6000rpm new overlock	17	Flatbed interlock machine	23
Other type overlock	18	Cylinder bed interlock machine	24
Special overlock	19	Taiwan design cylinder bed interlock machine	25
Automatic overlock	20		

SPECIAL MACHINE

Eyelet button holing machine	26	Button attach machine	32
Straight button holing machine	27	Pattern sewing machine	33
Feed off the arm machine	28	Special pattern sewing machine	34
Special bar tacking machine	29	Template programmable sewing machine	35
Bar tacking machine	30	Template engrave machine	36
Auto button feeder	31		

AUTOMATION

Automatic double needle belt loop machine	37	Automatic t-shirt bottom hemming machine	50
Belt pulley feed off the arm with automatic trimmer function	38	Automatic placket setting machine for polo t-shirt	51
Automatic pocket setter	39	Pants pocket facing unit	52
High speed coin pocket setter	40	Automatic pocket laser opener	53
Automatic pocket mouth curling machine	41	Automatic pocket welting machine for pants	54
Automatic trousers bottom hemming machine	42	Dart & pleats sewing unit for suit pants	55
Automatic waistband sewing machine	43	Automatic button wrapping sewing machine for pants	56
Automatic snap button attach machine	44	Hand stitch series for suits	57
J-stitch pattern sewing machine	45	Suits machine	58
Automatic overlock machine	46	Automatic elastic ribbon splicing machine	59
Shirt sleeve placket machine	47	Automatic string thrusting machine for sports wear	60
Automatic pocket setter for shirts / t-shirt	48	Left hand sewing machine	61
Shirt button attach & holing machine	49		

OTHER SPECIAL MACHINE

High speed zigzag machine	62	Heavy duty bag closer machine	68
Zigzag sewing machine	63	Thread distributor& bobbin winder	69
Blind stitch machine	65	Plastic staple machine	70
Hand stitch & material splitting machine	66	Snap button attach machine	71
Bag closer machine	67	Pearl & beads machine	72

MULTI NEEDLE

Cylinder bed multi-needle series	73	Flat bed multi-needle series	75
----------------------------------	----	------------------------------	----

HEAVY DUTY

Top & bottom feed lockstitch	78	Extra heavy duty machine	88
Post bed machine bearing construction	79	Shoes machine	89
Post bed machine	81	Shoes innerside trimming machine	90
Cylinder bed compound feed lockstitch	83	Fur sewing machine & upper drawing machine	91
Compound feed lockstitch	84	Upper drawing machine	92
Special heavy duty machine	85	Shoes machine	93
Long arm compound feed lockstitch	86	Shoes heel lining separating sides ,pounding machine	94
Heavy duty pattern sewing machine	87		

CUTTING

Cutting cloth and leather strip machines	95	Small round knife cutting machine	101
Computerized fully-automatic strip cutting machine	96	Belt loop cutter series	103
Band knife cutting machine	97	Laser cutting machine	105
End cutter machine	98	Automatic cutting bed	107
Straight knife cutting machine	99	Single layer auto cutting machine	109
Thread cleaning machine	100	Spreader	110

PLOTTER & FABRIC PREPARE

Fabric inspection & relaxing & loading	111	Plotter	113
Fabric shrinking & forming / transduction bias	112	Flat bed inkjet cutting machine	115
Cloth rewinder / aligning & folding stitching machine			

IRONING SERIES

Pocket creasing & turn machine	116	Ushape ironing table	125
Fusing machine	117	Suit pants heat ironing machine series	127
Heat transfer machine	118	Iron	128
Pad printing machine serie	119	Auto baseball cap ironing machine	129
Press machine	120	Shirts heat ironing machine series	130
Shirts collar & cuff machine	121	Electrically heated steam boiler	131
Finish machine	122	Full automatic gas-fired steam boiler	134
Ironing table	123		

EMBROIDERY & OTHER TEXTILE MACHINE

NEEDLE DETECTOR	135	MATTRESS MACHINE	140
EMBROIDERY MACHINE	136	FULL AUTOMATIC FILLING MACHINE	141
COMPUTERIZED FLAT KNITTING MACHINE	139		

DOMESTIC & ULTRASONIC & OTHERS

DOMESTIC MACHINE	143	TABLE & STAND	148
HOT AIR SEAM MACHINE	145	MOTOR	149
ULTRASONIC MACHINE	147	PULLEY & DEVICE	150



V-9000A



V-A2S



V-E4S



V-88S



V-F6



V-9000S

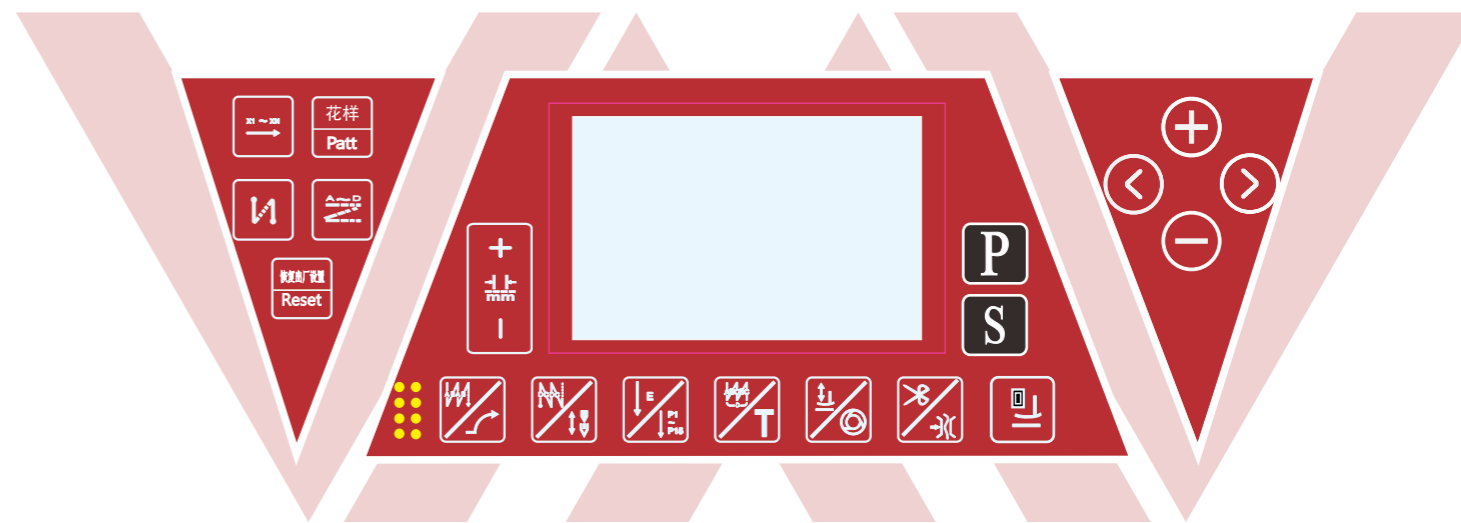

NEWEST ARRIVED

NEW ELECTRONIC LOCKSTITCH



V-9000A

Product Overview:

- Newest design electronic lockstitch
- Thread goes down straight from take-up lever to electric tension, then to the needle without twist
- **Maximum operating speed: For 4000rpm on the production line**, after three months raise up to 4200rpm, after six months raise up to 4500rpm

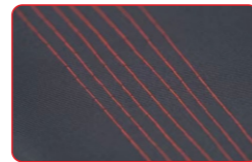

Machine details:



Model	Needle	Thread	Stitch length	presser foot height	Speed	Weight	Measurement
V-9000A	DBx1(#11-#18)	2	5mm	5-13mm	4500rpm	33/36kg	63x24.5x54cm
V-9000A-7	DBx1(#11-#18)	2	7mm	5-13mm	4500rpm	33/36kg	63x24.5x54cm

NEW DIRECT DRIVE LOCKSTITCH



V-F6

Product Overview:

- High quality spare parts
- **3700rpm from production line**, not 3500rpm
- Metal presser adjusting screw nut
- Thicker thread stand and better bobbin base

Machine details:

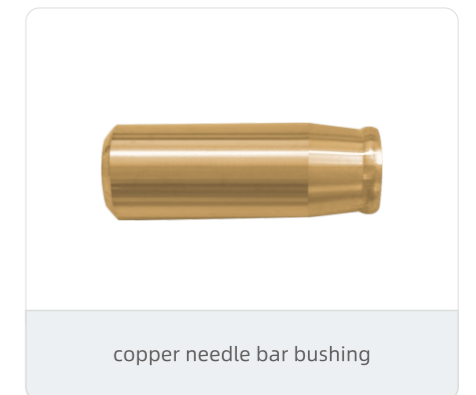

Model	Needle	Thread	Stitch length	Presser foot height	Speed	Weight	Measurement
V-F6	DBx1 11-18#	2	5mm	5-13mm	5000rpm	29.5/36.5kg	59x23x55cm
V-F6H	DBx1 19-23#	2	5mm	5-13mm	4000rpm	29.5/36.5kg	59x23x55cm

ELECTRONIC LOCKSTITCH



V-9000A

Top quality electronic lockstitch



V-9000S

Single Step motor electronic lockstitch



V-8000A

Top quality electronic lockstitch



V-8000S

Single Step motor electronic lockstitch



V-A4F-SS

Double step motor double knife electronic lockstitch



V-A4F-SST

Double step motor double knife electronic lockstitch with touch screen

Model	Needle	Thread	Stitch length	presser foot height	Speed	Weight	Measurement
V-9000S	DBx1(#11-#18)	2	5mm	5-13mm	4500rpm	33/36kg	63x24.5x54cm
V-9000S-7	DBx1(#11-#18)	2	7mm	5-13mm	4500rpm	33/36kg	63x24.5x54cm
V-A4B(big hook)	DBx1(#18-#22)	2	7mm	5-13mm	4000rpm	33/36kg	63x24.5x54cm

DIRECT DRIVE & TRIMMER ONLY LOCKSTITCH



DIRECT DRIVE



V-F6

Direct drive lockstitch



V-F5

Direct drive lockstitch



V-M8

Direct drive lockstitch



V-M1

Direct drive lockstitch

ONLY TRIMMER



V-A2S

Only trimmer direct drive lockstitch



V-A1D

Only trimmer direct drive lockstitch

ELECTRONIC LOCKSTITCH



V-A4

Electronic lockstitch



V-7000A

Single Step motor electronic lockstitch

Model	Needle	Thread	Stitch length	Presser foot height	Speed	Weight	Measurement
V-F6	DBx1 11-18#	2	5mm	5-13mm	5000rpm	29.5/36.5kg	59x23x55cm
V-F6H	DBx1 19-23#	2	5mm	5-13mm	4000rpm	29.5/36.5kg	59x23x55cm
V-A4	DBx1 (#11-#18)	2	5mm	5-13mm	4500rpm	33/36kg	63x24.5x54cm
V-A4-7	DBx1 (#11-#18)	2	7mm	5-13mm	4500rpm	33/36kg	63x24.5x54cm

MECHANICAL LOCKSTITCH



V-8700

V-8700-7 is 7mm stitch length;
V-8700H-7 is heavy duty stitch length 7mm



V-8500

Conventional lockstitch



V-6150

Conventional lockstitch



V-6-9

Big hook lockstitch



V-202

Heavy duty lockstitch



V-202D

Heavy duty lockstitch

Model	Needle	Thread	Stitch length	Presser foot height	Speed	Weight	Measurement
V-8700	DBx1 11-18#	2	5mm	5-13mm	5000rpm	29.5/36.5kg	59x23x55cm
V-6150	DBx1 11-18#	2	5mm	5-13mm	5000rpm	29.5/36.5kg	59x23x55cm
V-202	DPx1 16-20#	2	9mm	6-13mm	2500rpm	29.5/34.5kg	58x23x53cm

NEEDLE FEED LOCKSTITCH



V-A7 / V-A7B (Big hook)

Electronic needle bar feed lockstitch



1. DLC needle bar, high-precision parts needle bar bracket, copper needle bar slider, the most important parts in this machine.
2. Integrated manufacturing of the crank and feed driving shaft, stronger stability.
3. Screws, thread take-up levers, needle bar cranks same as Juki parts.
4. Powermax control box, auto trimmer, auto back sewing, auto backtack, option auto presser foot lifter.



V-A7K

Edge cutter needle bar feed lockstitch



V-6160T

only trimmer needle bar feed lockstitch



**V-6160DS & V-6160DSH
& V-6160DSB**

Simple direct drive needle bar feed lockstitch

Model	Needle	Thread	Stitch length	Presser foot lifter amount	Speed	Weight	Measurement
V-A7	DBx1 11-18#	2	5mm	5-13mm	4500rpm	34.5/41.5kg	63.5x24.5x55cm
V-A7B	DBx1 18-21#	2	5mm	5-13mm	3500rpm	45/39kg	68x29x59cm

EDGE CUTTER LOCKSTITCH



V-5559E
Electronic lockstitch with edge cutter



Desheng hook

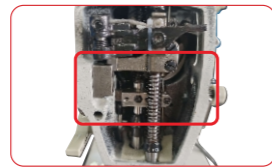

Brother original knife shaft guide
moreabrasion resistant



Low sound with or without knife
when 3500rpm



Cutter use hardness special
metal material



StrongH knife

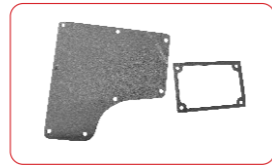

Oil reservoir gasket avoid oil leakage



V-5300S

Single step motor lockstitch with edge cutter full function,
closed oil pan, head oil free



V-5559D

Direct drive lockstitch with edge cutter

Model	Needle	Thread	Stitch length	Presser foot lifter amount	Speed	Weight	Measurement
V-5200E	DBx1 11-18#	2	4mm	5-13mm	4500rpm	34.5/41.5kg	63.5x24.5x55cm

LONG ARM LOCKSTITCH



V-99L-85-PR
Electronic long arm lockstitch 85cm



V-99L-56-PR
Electronic long arm lockstitch 56cm

LONG ARM ELECTRONIC LOCKSTITCH MACHINE

With big operate space; Presser foot lifter height reach to 2.6cm;
With electronic pulley which make transport more smoothly even working during the revers back sewing, also can adjust the speed of pulley;
With air vacuum table, more easy to operate for big size cloth; After trimmer needle bar automatically raised up to avoid collision with plates.

Model	Needle	Thread	Stitch length	Presser foot lifter amount	Speed	Weight	Measurement
V-99L-56/85	DBx1 18-21#	2	5mm	5-26mm	3500rpm	82/90kg	150x37x65cm

DOUBLE NEEDLE LOCKSTITCH



V-8750E-405
Electronic double needle machine
flat trimmer(straight knife)



V-842DX/V-872DX
Direct drive double needle machine
fixed needle bar, standard/big hook;



V-8421A
Double needle with tape feeding
device and electronic pulley



V-58420E-ATP
Electronic double needle with auto
cutting tape device



V-845DX/V-875DX
Direct drive double needle machine split
needle bar standard/big hook;



V-842/V-872
Double needle machine fixed needle
bar standard hook/big hook;



V-845/V-875
Double needle machine splitter
needle bar standard hook/big hook

CHAIN STITCH



V-8558D
Direct drive double needle chain stitch



V-8558
Double needle chain stitch



V-8560D
Direct drive three needle chain stitch



V-8560
Three needle chain stitch



V-8560-2PL
Three needle chain stitch with double pulley



V-8558DT
Top & bottom feed direct drive double
needle chain stitch machine



V-3800S-7
Chain stitch sewing machine with device for pleating

Auto cutting device



Tape Cutter



Needle Plate



Cover Plate



Electromagnet



Direct Drive Moter



All-in-one
Electronic Control

Model	Needle	Thread	Presser foot lifter amount	Auto foot lifter	Needle gauge	Speed	Needle position	Auto back sewing	Auto trimmer	Weight	Measurement
V-58420E-405	Dpx5 11-22#	4	7-13mm	○	1/8" 5/32" 7/32" 1/4" 5/16" 3/8" 1/2"	4000rpm	○	○	○	50/55kg	72.5x32x67.5cm
V-58450E-405	DPx5 11-22#	4	7-13mm	○	1/8" 5/32" 7/32" 1/4" 5/16" 3/8" 1/2"	4000rpm	○	○	○	50/55kg	72.5x32x67.5cm
V-58720E-405	DPx5 11-22#	4	7-13mm	○	1/8" 5/32" 7/32" 1/4" 5/16" 3/8" 1/2"	4000rpm	○	○	○	50/55kg	72.5x32x67.5cm
V-58750E-405	DPx5 11-22#	4	7-13mm	○	1/8" 5/32" 7/32" 1/4" 5/16" 3/8" 1/2"	4000rpm	○	○	○	50/55kg	72.5x32x67.5cm

Model	Needle	Thread	Stitch length	Presser foot lifter amount	Speed	Needle gauge	Weight	Measurement
V-8558D-1	9-21#	4	4	8-10	4500rpm	1/4"	33.5/41kg	62.5x25x56.5cm
V-8558D-2	9-21#	2	4	8-10	4500rpm	/	33.5/41kg	62.5x25x56.5cm
V-8560D	9-21#	6	4	8-10	4500rpm	1/4"	33.5/41kg	62.5x25x56.5cm

DIFFERENTIAL TRANSPORTATION LOCKSTITCH



V-5490U-7

step motor electronic bottom differential lockstitch



V-5490B-7

step motor electronic bottom differential lockstitch

Advantage:

- 1.Integrating the main servo system and auxiliary differential programming system of the entire machine.
- 2.New type of step motor shaft direct differential component to complete the action of changing the differential. Cancel of the mechanical transmission components and Hall induction in the middle of traditional differential sewing machines to avoid the common faults of traditional models. A step differential adjustment device for flat sewing machines.
- 3.The feeding and pressing foot has the function of adjusting the feeding quantity for back sewing. During differential feeding (such as pleating) back sewing can achieve top and button feed.
- 4.The top differential feeding amount is adjusted by a knob, and adjust synchronous or differential feeding according to demand. Implemented low tension sewing to suppress wrinkling, sewing misalignment, and other questions. Reducing workers' operating skills and providing quality and efficiency.
- 5.Auxiliary tools include standard aircraft gauges, thread pressing fixtures, pleats, specialized knives, etc. Through the exchange of dozens of different presser foot, the machine can be versatile and adapt to the diversity of fabrics. Realize multi-purpose use of one machine.

Machine display:

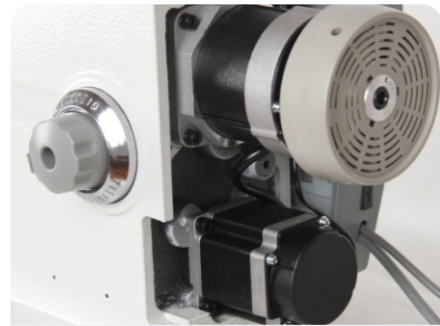

Step motor

Scope of application:

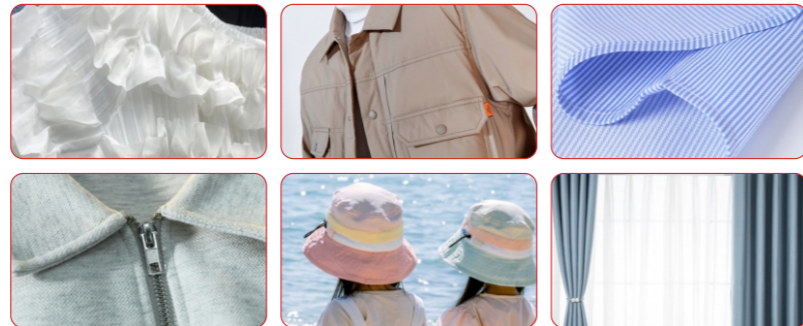

Thin material/stretch fabric/home textile/zipper front/bag hem/upper hat brim, etc.

Model	Needle	Thread	Stitch length	Top feed amount	Presser foot height	Speed	Weight	Measurement
V-5490	DBX1(14#)	2	5mm	8mm	13mm	4000rpm	38/41kg	69x26x52.5cm

UPPER DIFFERENTIAL



V-5490N-7

Computer controlled sewing machine with upper differential device

Scope of application:

For women wear / fashionable dress/ performing clothes pleating; women wear / fashion dress/ shirt bottom hem; Jacket / down jacket / coat placket sewing; home textile / curtain / mattress and so on.



V-5493N-7-QG-S

Upper and lower differential device for curve lower hem (computer divide sections automatically)

Scope of application:

Shrink 1:1.5, expand 1:0.5; For shirt, S shape lower hem; women' wear / fashion dress / curve shape lower hem sewing; rolling lower hem for chiffon fabric; pleating / placket sewing / joining sleeve and so on.



V-7591

Upper differential lockstitch with edge cutter and folder



V-4481

Upper differential flatbed chain stitch. HEAD ONLY



Model	Needle	Thread	Stitch length	Top feed amount	Presser foot height	Speed	Weight	Measurement
V-5490N-7	DBX1(14#)	2	5mm	8mm	13mm	4000rpm	38/41kg	69x26x52.5cm

CYLINDER BED LOCKSTITCH SERIES



SWEATER USE



V-A45-CY Upper differential cylinder bed computerized lockstitch
Semi-oil cylinder bed computerized lockstitch with pulley
Upper differential cylinder bed computerized lockstitch

V-A45-CY-PL for pans hemming

V-A45-CY-FR01 With expanding device



V-A45-CY-TD
upper differential cylinder bed
computerized lockstitch



V-6490-7

Upper differential cylinder bed
computerized lockstitch

Scope of application:

Replace needle feed machine, avoid back sewing thread broken/
thin material stitches beautiful/ elastic material not elongate.



V-6090-7-PR

Semi-oil cylinder bed computerized
lockstitch with pulley

Scope of application:

Make sure the feed dog and pulley with same transport amount.

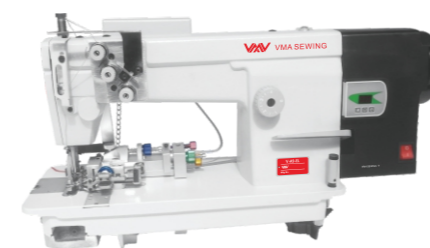

V-A9-EL
Sweater joint chain stitch high speed



V-A9-GR
Sweater joint chain stitch round design 600rpm

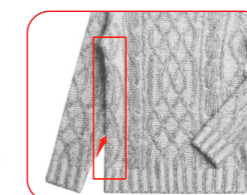

V-S916
Direct drive sweater fell seaming machine



V-A9-GRH
Sweater joint chain stitch round design 1200rpm

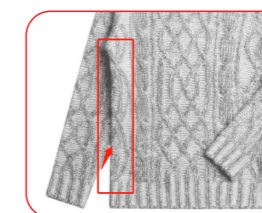

V-TF916-D7

Automatic vertical sweater sewing machine

Product Overview:

- Machine is suitable for closing sleeves and sides of fully garments
- Vertical design improve efficiency 3-5 times
- Motor control presser disc and needle disc auto separate or close
- With 10 inch touch screen, and 8 motors
- Maximum speed reach to 3200rpm.

Model	Needle	Thread	Stitch length	Top feed amount	Presser foot height	Speed	Weight	Measurement
V-6090-7-PR	DBx1(14#)	2	4mm	8mm	13mm	4000rpm	38/41kg	69x26x52.5cm

Model	Sewing speed	Needle	Stitch length	Voltage	Weight	Measurement
V-TF916-D7	3200RPM	DPX5	1-5MM	220V	26/33kg	40x40x40cm



V-E4S

Product Overview:

- 1.Closed needle bar head
- 2.Option auto trimmer fucation
- 3.More stable needle bar

Machine details:



Fast speed, light sound, four-ball main shaft, with stable sewing performance and beautiful appearance

Model	Needle	Needle quantity	Thread	Needle guage	Stitch width	Stitch length	Differential	Presser foot height	Speed	Weight	Measurement
V-E4S-4	Dcx27# 11	2	4	2	4mm	3.6mm	0,7-2	5mm	6000rpm	29/35kg	46.5x34x50cm
V-E4S-5	DCx27# 14	2	5	3	5mm	3.6mm	0,7-2	5mm	6000rpm	29/35kg	46.5x34x50cm
V-E4S-5H	DCx27# 19	2	5	5	6mm	5mm	0,7-1,4	5mm	6000rpm	29/35kg	46.5x34x50cm



V-E4N

Product Overview:

- Machine body heavy 4kg heavier, more stable.
- Use good spare parts, more wear-resisting.
- Needle bar avoid oil leakage.
- Lift the presser foot up to 5 mm.
- Control box build in machine body.
- Speed reaches to 5000rpm , sewing without material will not break thread.

Machine details:



Fast speed, light sound, four-ball main shaft, with stable sewing performance and beautiful appearance

Model	Needle	Needle quantity	Thread	Needle guage	Stitch width	Stitch length	Differential	Presser foot height	Speed	Weight	Measurement
V-E4N-4	Dcx27# 11	2	4	2	4mm	3.6mm	0,7-2	5mm	6000rpm	29/35kg	46.5x34x50cm
V-E4N-5	DCx27# 14	2	5	3	5mm	3.6mm	0,7-2	5mm	6000rpm	29/35kg	46.5x34x50cm
V-E4N-5H	DCx27# 19	2	5	5	6mm	5mm	0,7-1,4	5mm	6000rpm	29/35kg	46.5x34x50cm

6000RPM NEW OVERLOCK



STEP MOTOR



SOLENOID

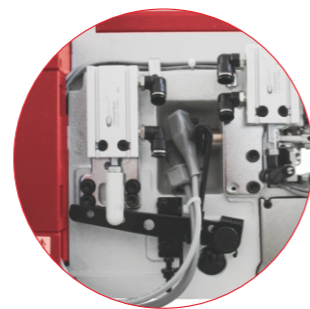

PNEUMATIC



V-885

Full automatic overlock electronic control



AUTO BACK LATCHING

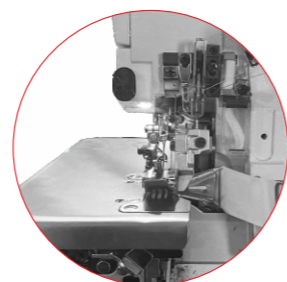

POCKET BINDING

OTHER TYPE OVERLOCK



V-E4N

Direct drive overlock machine



V-E5AT-4

Step motor high speed overlock machine



V-E3N

Newest overlock, head was closed avoid oil leakage.



V-747-BK

Overlock conventional



V-700D-GL

Overlock with back latching



V-747

Direct drive overlock machine

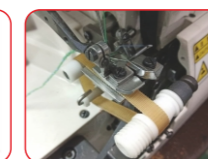

For gloves

Model	Needle	Needle quantity	Thread	Needle guage	Stitch width	Stitch length	Differential	Presser foot height	Speed	Weight	Measurement
V-88S-3	DCx27#9	1	3	-	3-5mm	3.8mm	0.7-2	5mm	7000rpm	35/40kg	51.5x35.5x56.6cm
V-88S-4	DCx27#11	2	4	2	5-6mm	3.8mm	0.7-2	5.5mm	7000rpm	35/40kg	51.5x35.5x56.6cm
V-88S-5	DCx27#11	2	5	3	5-6mm	3.8mm	0.7-2	5.5mm	6500rpm	35/40kg	51.5x35.5x56.6cm
V-88S-5H	DCx27#19	2	5	5	5-6mm	5mm	0.8-1.5	7mm	6000rpm	35/40kg	51.5x35.5x56.6cm

Model	Needle	Needle quantity	Thread	Needle guage	Stitch width	Stitch length	Differential	Presser foot height	Speed	Weight	Measurement
V-E4N-3	DCx27# 9	1	3	-	4mm	3.6mm	0,7-2	5.5mm	6000rpm	29/35kg	46.5x34x50cm
V-E4N-4	DCx27# 11	2	4	2	4mm	3.6mm	0,7-2	6mm	6000rpm	29/35kg	46.5x34x50cm
V-E4N-5	DCx27# 14	2	5	3	5mm	3.6mm	0,7-2	6mm	5500rpm	29/35kg	46.5x34x50cm
V-E4N-5H	DCx27# 19	2	5	5	6mm	5mm	0,7-1,4	6mm	5000rpm	29/35kg	46.5x34x50cm

SPECIAL OVERLOCK



V-95ATS-7

Top differential overlock machine, full automatic new design, control box build in machine body



V-95ATS-T4/PB

Top differential overlock machine pocket binding, control box build in machine body



V-5214DV

Top quality automatic overlock machine use for can 7000rpm reach to



V-997D

Cylinder bed overlock direct drive

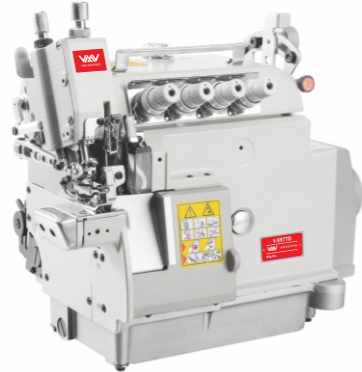

V-997TD

Cylinder bed overlock direct drive with top differential

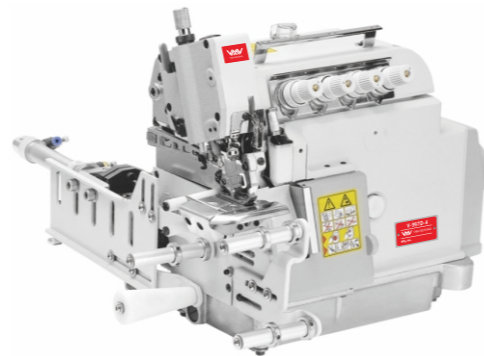

V-997D-4/KS-FR01

With auto trimmer and cloth expanding device

Model	Needle	Needle quantity	Thread	Needle guage	Stitch width	Stitch length	Differential	Presser foot height	Speed	Weight	Measurement
V-998D-3	DCx27#9	1	3	-	3-5mm	3.8mm	0.7-2	5mm	7000rpm	35/40kg	51.5x35.5x56.6cm
V-998D-4	DCx27#11	2	4	2	5-6mm	3.8mm	0.7-2	5.5mm	7000rpm	35/40kg	51.5x35.5x56.6cm
V-998D-5	DCx27#11	2	5	3	5-6mm	3.8mm	0.7-2	5.5mm	6500rpm	35/40kg	51.5x35.5x56.6cm
V-998D-5H	DCx27#19	2	5	5	5-6mm	5mm	0.8-1.5	7mm	6000rpm	35/40kg	51.5x35.5x56.6cm

AUTOMATIC OVERLOCK



V-997TD-4-ATE

Top differential 4 thread cylinder bed overlock, with automatic feeding material device for circular collar or waist setter, with KS device for auto trimmer / presser foot lifter / suction

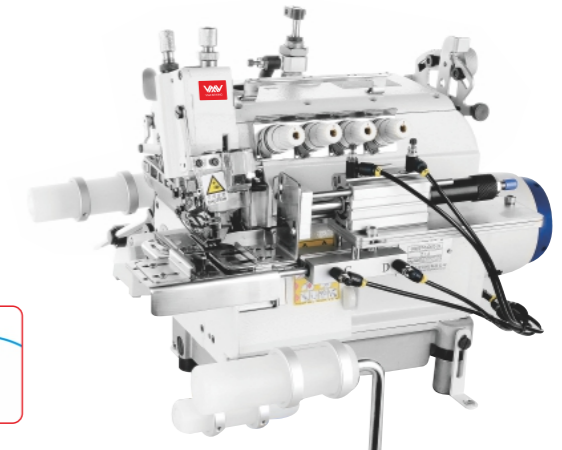
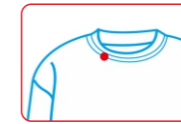

V-997TD-4-ELC

Top differential 4 thread cylinder bed overlock, with semi automatic device for circular collar or waist setter, with KS device for auto trimmer / presser foot lifter / suction



V-997TD-4-AT SX

Top differential 4 thread cylinder bed overlock, with automatic device for sports wear cuff setter, diameter of sleeve 8-16cm, 100-120pcs per hour. with KS device for auto trimmer / presser foot lifter / suction

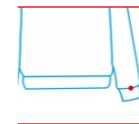

V-997D-4/KS-MAC18K

Cylinder bed overlock 4 thread with KS chain cutter & presser foot lifter, with electronic feeding and cutting device, suitable for underwear / swimming cloth / skirts and so on

Model	Needle	Needle quantity	Thread	Needle guage	Stitch width	Stitch length	Differential	Presser foot height	Speed	Weight	Measurement
V-997D-3	DCx27#9	1	3	-	3-5mm	3.8mm	0.7-2	5mm	7000rpm	30.1/35.6kg	47.2x49.5x36cm

FLAT-SEAMER 4 NEEDLE 6 THREAD MACHINE



V-701

Product Overview:

- Fully oil-sealed design, without oil pollution.
- For various materials, such as single jersey to fleece, stretchable and uneven thickness portion, overlapping amount of upper/lower fabric ect.
- 148mm cylinder bed , 200mm length sewing bed, suitable for widely operation.
- Easy to adjust the differential ration by outer lever.
- Thread tension can be adjusted individually for neat stitch formation.

Notice:

- Most common material use double side cutting.
- Thin material mostly use single side cutting, model start from V-6200DS.
- Needle guage has 5.2mm or 6.0mm.
- With automatic trimmer function. Model start from V-6200DK/V-6200DSK.

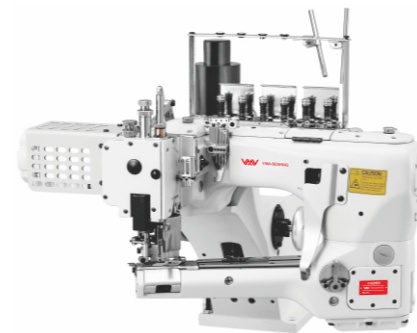

V-6200D

Model	Usage	Needle	Thread	Needle guage	Stitch length	Needle bar move	Auto foot lifter	Presser foot height	Speed	Weight	Measurement
V-6200D-01MR-5,2/6,0-D(-7)	Knitting	GBx118 11#	6	5.2/6.0	1.6-2.5mm	30	★	6mm	4000rpm	23/31kg	59x39x49cm
V-6200D-01MS-5,2/6,0-D(-7)	Knitting	GBx118 11#	6	5.2/6.0	1.6-2.5mm	30	★	6mm	4000rpm	23/31kg	59x39x49cm
V-6200D-02MR-5,2/6,0-D(-7)	Sportswear	GBx118 11#	6	5.2/6.0	1.6-2.5mm	30	★	6mm	4000rpm	23/31kg	59x39x49cm
V-6200D-02MS-5,2/6,0-D(-7)	Sportswear	GBx118 11#	6	5.2/6.0	1.6-2.5mm	30	★	6mm	4000rpm	23/31kg	59x39x49cm
V-6200D-03MR-5,2/6,0-D(-7)	Sock	GBx118 11#	6	5.2/6.0	1.6-2.5mm	30	★	6mm	4000rpm	23/31kg	59x39x49cm
V-6200D-03MS-5,2/6,0-D(-7)	Sock	GBx118 11#	6	5.2/6.0	1.6-2.5mm	30	★	6mm	4000rpm	23/31kg	59x39x49cm
V-6200D-04MR-5,2/6,0-D(-7)	Thermal underwear	GBx118 11#	6	5.2/6.0	1.6-2.5mm	30	★	6mm	4000rpm	23/31kg	59x39x49cm
V-6200D-04MS-5,2/6,0-D(-7)	Thermal underwear	GBx118 11#	6	5.2/6.0	1.6-2.5mm	30	★	6mm	4000rpm	23/31kg	59x39x49cm
V-6200D-05MR-5,2/6,0-D(-7)	Diving suit	GBx118 11#	6	5.2/6.0	1.6-2.5mm	30	★	6mm	4000rpm	23/31kg	59x39x49cm

NEW INTERLOCK



V-561DF

Product Overview:

- 1. High quality spare parts;
- 2.Thread cam outside
- 3.control box build in
- 4.Option auto trimmer & foot lifter, use step motor control

Machine details:

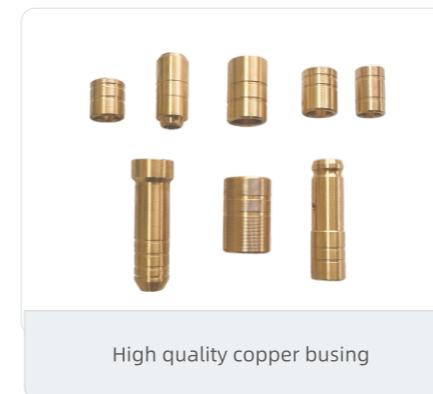

High quality copper busing

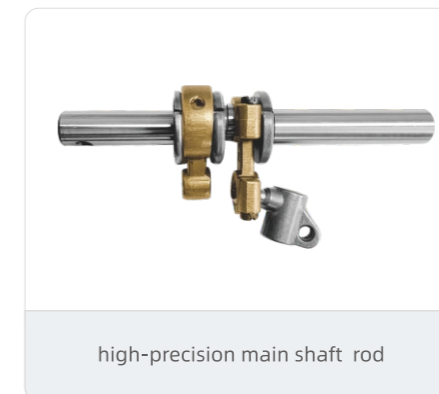

high-precision main shaft rod



thread cam outside

Model	Needle	Needle quantity	Thread	Needle guage	Stitch width	Stitch length	Differential	Presser foot height	Speed	Weight	Measurement
V-561D-01GB	# 9-11	3	5	364/356	4.4mm	0.5-3.8mm	0.5-1.3	5.5mm	6000rpm	45/50kg	58x38x63cm
V-561E-01GB	# 9-11	3	5	364/356	4.4mm	0.5-3.8mm	0.5-1.3	5.5mm	6000rpm	50/55kg	58x38x63cm

FLAT BED INTERLOCK MACHINE



V-561DF

Direct drive interlock control box build in



V-561ES-01x364/EUT

Step motor control, auto trimmer flat bed interlock

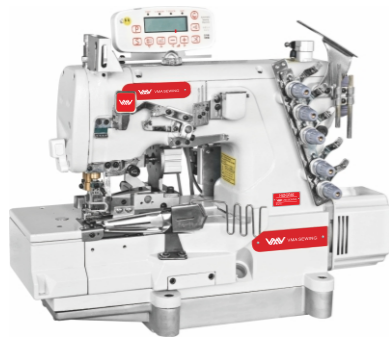

V-562D-02ATx364

Tape binding interlock with auto cutting tape device



V-562D-05CBx364

Flat bed interlock with elastic device right side knife for lace



V-562D-07ATCx356

Direct drive flat bed interlock with loop cutting knife at front, with loop length auto cutting device at back side

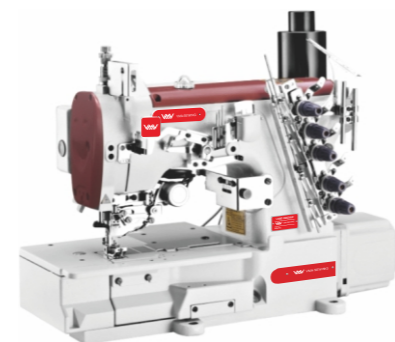

V-F858ET-01GBx356/EUT

Top feed flat bed interlock

CYLINDER BED INTERLOCK MACHINE



V-664E-01GBx364/UT

Auto trimmer cylinder bed interlock

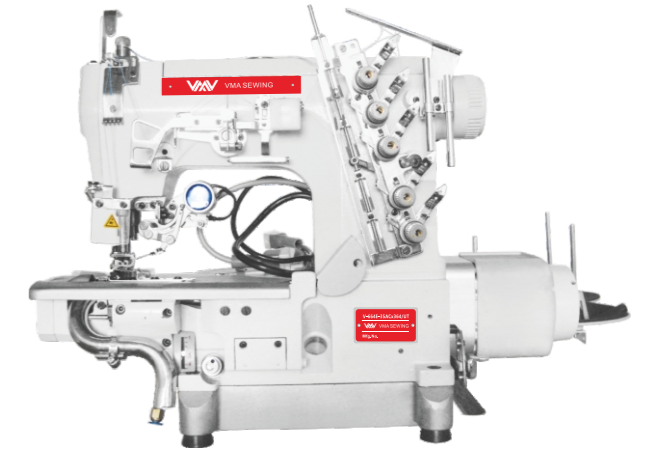

V-664E-35ACx364/UT

Bottom hemming auto trimmer with left knife cylinder bed interlock

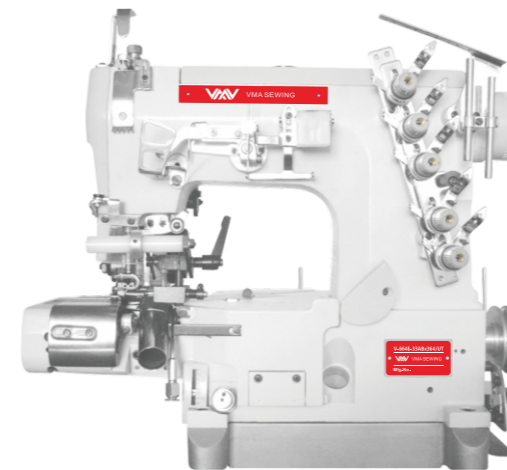

V-664E-33ABx364/UT

Elastic with right side knife and pulley cylinder bed interlock



V-664-01GBx364-PL

Cylinder bed interlock with pulley

Model	Needle	Needle quantity	Thread	Needle gauge	Stitch width	Stitch length	Differential	Presser foot height	Speed	Weight	Measurement
V-562D-01GB	# 9-11	3	5	364/356	4.4mm	0.5-3.8mm	0.5-1.3	5.5mm	6000rpm	45/50kg	58x38x63cm
V-562E-01GB	# 9-11	3	5	364/356	4.4mm	0.5-3.8mm	0.5-1.3	5.5mm	6000rpm	50/55kg	58x38x63cm

Model	Needle	Needle quantity	Thread	Needle gauge	Stitch width	Stitch length	Differential	Presser foot height	Speed	Weight	Measurement
V-664D-01GB/UT	#9-11	3	5	364/356	4.4mm	0.5-3.8mm	0.6-1.3	5.5mm	6000rpm	48/54kg	63x40x63cm
V-664E-35AC/UT	#9-11	3	5	364/356	4.4mm	0.5-3.8mm	0.6-1.3	5.5mm	6000rpm	48/54kg	63x40x63cm
V-7600D-01GB/UT	#11-14	3	5	364/356	4.4mm	1.4-3.6mm	0.6-1.3	12mm	3000rpm	50/55kg	63x40x63cm

TAIWAN DESIGN CYLINDER BED INTERLOCK MACHINE

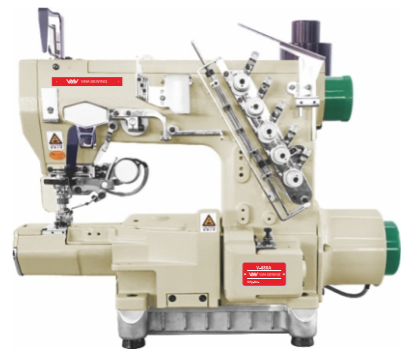

V-888A

Cylinder bed interlock Taiwan design

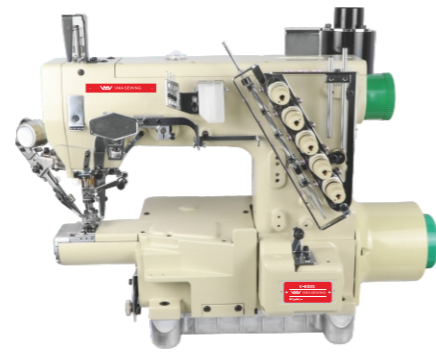

V-888S

Smallest bed interlock TaiWan design

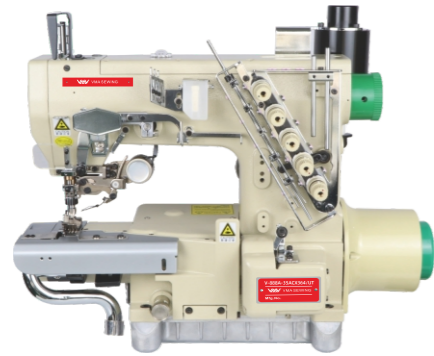

V-888A-35ACX364/UT

TAIWAN design auto trimmer cylinder bed interlock with left cutting knife for bottom hemming



V-888A-33ABx364/UT

TaiWan design auto trimmer cylinder bed interlock for elastic with right side knife and pulley

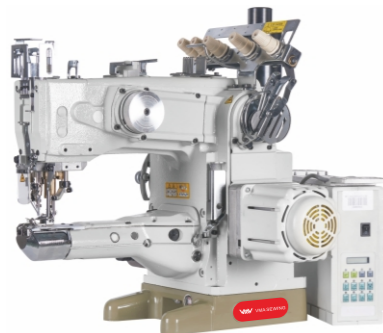

V-1500E-156Mx356/UT

Electronic interlock Japan design

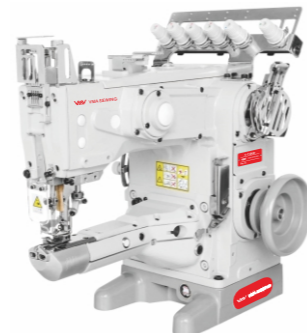

V-1500D

Direct drive interlock Japan design

Model	Needle	Needle quantity	Thread	Needle gauge	Stitch width	Stitch length	Differential	Presser foot height	Speed	Weight	Measurement
V-888A-01GB/UT	#9-11	3	5	364/356	4.4mm	0.5-3.8mm	0.6-1.3	5.5mm	6000rpm	48/54kg	63x40x63cm
V-888A-35ACx364/UT	#9-11	3	5	364/356	4.4mm	0.5-3.8mm	0.6-1.3	5.5mm	6000rpm	48/54kg	63x40x63cm

EYELET BUTTON HOLING MACHINE



Option finger switch



V-9820

Option model V-9820FAT, come with auto feeding system

Specifications	V-9820	V-9820-01	V-9820-02	
			L2230	L1826'1
Upper thread trimmer	Long thread cut	Long thread cut	Short thread cut	
Lower thread trimmed	None	Long thread cut	Short thread cut	
Main applications	Men's wear, casual wear, jeans, trousers	Men's wear, casual wear	jeans	jeans, trousers
Other applications	Ladies'wear	Ladies'wear, jeans trousers		
Features	Only the upper' thread cut by the thread trimmer. Button holes length up to 50mm can be sewn.	All the threads are cut long by the thread trimmers. The long thread ends can be securely held in the subsequent process. It is suitable for cases that require accurate short end or manual trimming.	All the threads are cut short by the thread trimmers. This saves the trouble of manual trimming and reduces consumption of the thread.	
Sewing length	8-50mm 5-50mm Eyelet buttonhole:8-50mm Striaight buttonhole:5-50mm	8-42mm 5-42mm Eyelet buttonhole:8-42mm Striaight buttonhole:5-42mm	22-30mm*2 L1422(14-22mm)*3 L1826(18-26mm)*3 L2634(26-34mm)*3 L3442(34-42mm)*3	18-26mm*2 L1422(14-22mm)*3 L2230(18-26mm)*3 L2634(26-34mm)*3 L3442(34-42mm)*3
Sewing speed	1000-2500rpm			
Weight	Machine head:120kg Operation panel: 0.6kg Control box:14.2-16.2kg			
Power supply/ Power Consumption	Single phase 100V/200V 3-phase 200V/380V/400V,400V/A			

STRAIGHT BUTTON HOLING MACHINE



V-782SS

Double step motor straight knife button holing machine



V-1790

Electronic button holing



V-1790AT-2H

Electronic button holing machine for open the sports pants straight holes, 2 head in one table to save one operator



V-782

Mechanical button holing machine
V-783NV for sweater with reinforce function

Model	Needle	Needle quantity	knife	Thread	Knife	Presser foot height	Stitch length	Button holing size	Speed	Weight	Measurement
V-781E	DPx5 11-14#	1	1/4"	2	1	12mm	4mm	25x(2.5-4)	3600rpm	62/75kg	70x34x90.5cm
V-782E	DPx5 11-14#	1	1/4"	2	1	12mm	4mm	35x(2.5-5)	3600rpm	62/75kg	70x34x90.5cm
V-783E	DPx5 11-14#	1	1/4"	2	1	12mm	4mm	41x(2.5-4)	3600rpm	62/75kg	70x34x90.5cm
V-1790	DPx5 11-14#	1	1/4"	2	1	17mm	4mm	41x(2.5-5)	4200rpm	58kg	78x61x39cm
V-1792	DPx5 11-14#	1	1/4"	2	1	17mm	4mm	120x(2.5-5)	4200rpm	58kg	78x61x39cm

FEED OFF THE ARM MACHINE



V-927

Double needle



V-927D

Double needle direct drive



V-927-PLB

Double needle with double rubber pulley



V-927-PS

Double needle with Japan design pulley



V-928

Three needle



V-928D-PL

Three needle direct drive with single pulley



V-928D-2PL

Three needle direct drive with double pulley



V-928-PLB

Three needle with double rubber pulley



V-928-PS

Three needle with Japan design pulley

Model	Needle	Needle quantity	Thread	Stitch length	Speed	Presser foot height	Needle guage	Weight	Measurement
V-927-PLB	14#	2	4	3.5mm	4000rpm	8mm	3/16" 1/4" 1/8"	44/99kg	58x53x47cm
V-928D-2PL	21#	3	6	4.2mm	3600rpm	10mm	3/16" 1/4" 1/8"	44/99kg	58x53x47cm

SPECIAL BAR TACKING MACHINE

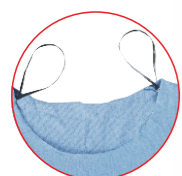

V-1900A-ATHL
Hanger loop sewing machine

Product Overview:

- Automatic operation, 4 seconds one piece, improve 4 times efficiency;
- Original JUKI head LK1900BSS;
- Ultrasonic cutting make sure the cutting head flat and beautiful;
- Length of loop adjustable;
- Stand height easy to adjust, more suitable for operators;
- Option loop roller device, suitable for high request customers.

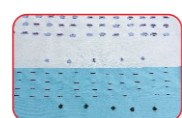

V-430AT-ST
Automatic lining attach bar tacking machine

Product Overview:

- Improve 3 times efficiency;
- Prevent hurt of skin friction, and avoid bar tack thread lose;
- Can use for bar tacking also can use for button attach;
- Siemens controller & SMC cylinder



V-1900A-STT
Bar tacking suction thread device for flatseam thread tail



V-3900AT
Electronic pillow bar tacking machine, working space reach to 117mm height, and 280mm length(Y direction), DaHao system with touch screen

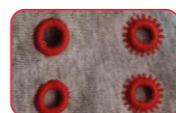

V-430ET-CK
bar tacking with punch hole function

Model	Sewing speed	Folding length	Voltage	Ultra power	Air pressure	Weight	Measurement
V-1900A-ATHL	3200RPM	25~400MM	220V	1200W/20KHZ	0.5MPA	130/150KG	130x75x130CM
V-430AT-ST	3000RPM	12~15MM	220V	-	0.5MPA	100/120KG	130x75x130CM

BAR TACKING MACHINE



V-430EQ
Electronic bar tacking machine control box build in



V-1900BSK
Electronic bar tacking machine control box build in with easy change button device



V-1850D
Direct drive bar tacking machine



V-1850
Mechanical bar tacking machine



Bar tacking Patterns

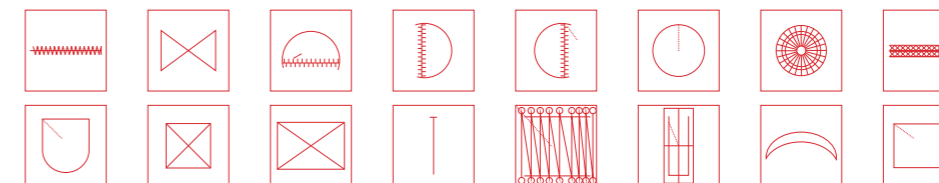

Model	Needle	Needle quantity	Thread	Speed	Bar tacking length	Bar tacking width	Stitches	Presser foot height	Weight	Measurement
V-1900A	DPx5 14-16#	1	2	3000rpm	20mm	4mm	15-150	14mm	45/57kg	80.6x37.5x74cm
V-1900LX	DPx5 14-16#	1	2	3000rpm	40mm	30mm	15-150	14mm	45/57kg	80.6x37.5x74cm
V-1906A	DPx5 14-16#	1	2	3000rpm	60mm	40mm	15-150	14mm	45/57kg	80.6x37.5x74cm

AUTO BUTTON FEEDER



V-918

Pneumatic control automatic button feeder device



V-918-VB

Automatic vertical metal button feeder device



V-998S

Logo recognize automatic button feeder device



V-438D+P918

Use for brother type machines



V-373D-AT

Use for normal machines



V-373D-VB-CP

Automatic vertical button attach machine

BUTTON ATTACH MACHINE



V-438EQ

Button attach machine with easy change bar tacking device



V-1903A

Electronic button attach machine



V-373D

Button attach direct drive



V-1377D

Button attach 3 design together direct drive



Different moulds

Button Attaching Patterns

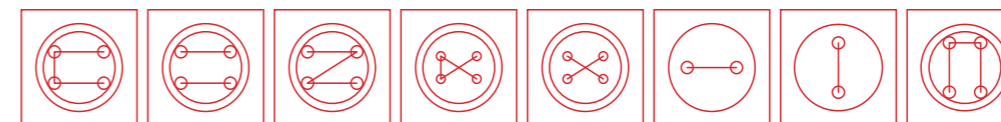

Model	Feeding speed	Button Size Diameter	Button thickness	power	Voltage	Air pressure	Weight	Measurement
V-918	0.45	9-20MM	1.8-4MM	400W	0.5MPA	0.5MPA	38KG	98x758x129CM

	Needle	Presser	Bobbin	Bobbin Size	Bobbin Size	Presser Foot	Presser Foot	Presser Foot	Speed	NW/GW	Dimension
	DPx17 14#	1	8-20	X(2.4-6.8) Y(2.4-6.8)	11	○	⊗	Ⓛ Ⓜ	2700rpm	42/73kg	80x37x73cm
V-373-1	TQx1 TQx7 14-18#	1	10-28	X(2.5-6.5) Y(0-6.5)	□9	○	⊗	Ⓛ Ⓜ	1500rpm	23/29kg	50.5x33x42cm
V-373-X	TQx1 TQx7 14-18#	1	10-28	X(2.5-6.5) Y(0-6.5)	□9	○	⊗	Ⓛ Ⓜ	1500rpm	23/29kg	50.5x33x42cm
V-1377	TQx1 TQx7 14-18#	1	10-28	X(2.5-6.5) Y(0-6.5)	□9	○	⊗	Ⓛ Ⓜ	1500rpm	23/29kg	50.5x33x42cm

PATTERN SEWING MACHINE



V-T2210D
Pattern sewing separate presser foot
sewing area 22x10cm

V-T2210D-FD3
Pattern sewing for label attach with sideslip
device sewing area 22x10cm



V-T3020D
Pattern sewing one whole presser foot
sewing area 30x20cm

V-T3525D
Pattern sewing machine
sewing area 35x25cm

V-T4530D
Pattern sewing machine
sewing area 45x30cm



V-6040DS
Pattern sewing large area 60x40cm



V-T1310D-APB
It is suitable for sewing leather tags or signs for
luggage and clothes
The sewing range is 13x10cm

SPECIAL PATTERN SEWING MACHINE



V-T2210D-VLT-U
Automatic velcro cutting & attach
machine (top feed), V-T2210D-VLT-B is bottom feed



V-T2210D-LAC
Pattern sewing long arm cylinder bed

V-T2210DS-LAC
Pattern sewing long arm cylinder
bed with two side clamp device



V-C3020
Mitsubishi type pattern sewing machine



V-3020D-F31-D
Pattern sewing machine with laser
cutting device



V-2210ATB-NY
Automatic bird eye machine

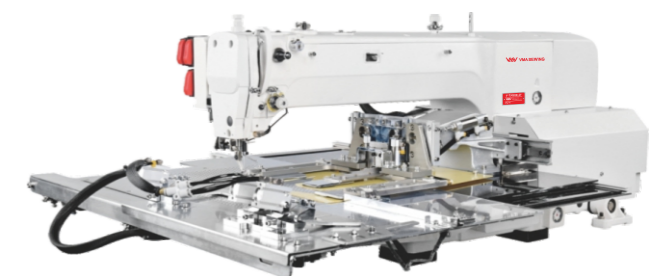

V-T3020D-CF
Pattern sewing for cap (brim of a hat)

Model	Sewing speed	Sewing area	Stitch length	Presser foot height	Power	Air pressure	Weight	Measurement
V-T1310DE	2700rpm	130x100mm	0.05~12.7mm	25mm	220V 550W	No need	140/180kg	122x84x132cm
V-T2210D	2700rpm	220x100mm	0.05~12.7mm	25mm	220V 550W	0.5Mpa 1.8L/min	140/180kg	122x84x132cm
V-T3020D	2700rpm	300x200mm	0.05~12.7mm	25mm	220V 550W	0.5Mpa 1.8L/min	220/280kg	122x122x132cm
V-T6040DS	2700rpm	220x110mm	0.05~12.7mm	25mm	220v 550w	0.5Mpa 1.8L/min	400/440kg	192x162x144cm

Model	Sewing speed	Sewing area	Stitch length	Presser foot height	Power	Air pressure	Weight	Measurement
V-3020D-F31-D	2700rpm	300x200mm	0.05~12.7mm	25mm	220v 550w	0.5Mpa 1.8L/min	190/220kg	142x160x142cm
V-T3020D-DN	2700rpm	300x200mm	0.05~12.7mm	25mm	220v 550w	0.5Mpa 1.8L/min	220/280kg	122x122x132cm

TEMPLATE PROGRAMMABLE SEWING MACHINE



V-15090R-LS

Rotary head with laser cutting system, working area 150*90cm



V-13085D-2S

Double screw guide, working area 130*85cm



V-13085D

Single screw guide, working area 130*85cm



V-5030DS-9000C

Intelligent lockstitch for open the knitting T-shirt bottom two side

Model	Sewing speed	Sewing area	Needle	Stitch length	Power	Air pressure	Weight	Measurement
V-12080DN	3500rpm	1300x800mm	DPx5(#7-#24),DPx17(#11-#24)	0.5~6mm	220V 600W	0.25~0.4Mpa(Max 0.5Mpa)	500/600kg	220x135x148cm
V-13085D	3500rpm	1300x850mm	DPx5(#7-#24),DPx17(#11-#24)	0.5~12.7mm	220V 600W	0.25~0.4Mpa(Max 0.5Mpa)	500/600kg	220x135x148cm

TEMPLATE ENGRAVE MACHINE



V-MP1809

Parameter:

- Own control system is more convenient for service
- The function of curve self-adaptive acceleration and deceleration is more smooth for accurate cutting
- Standard template output software, more easier for novice
- Automatic knife-matching function is convenient for replacement of milling cutters with various diameters

(Machine model) :	V-MP1809
(Cutting area) :	1500x900 1500x1200 1800x900(mm)
(Job characteristics) :	Strong compatibility,can be connected to any room a CAD software system
(Cutting material) :	Copper paper board PET board of PVC acrylic polymer composite materials
(Cutting method) :	Stroke graver multi diameter cutter (replaceable)
(Pen/Knife) :	Oil pen cutter blade edge (single/multi imported super steel cutter)
(Cutting speed) :	50- 800mm/s LED display touch screen
(Cutting thickness) :	≤10mm
(Fixed mode) :	Vacuum adsorption
(Repeat accuracy) :	≤0.01mm
(Software resolution) :	0.025mm/0.01 mm/0.1mm
(Instruction format) :	hpgl plt dxf
(Output port) :	Optional wireless output module
(Voltage/Power) :	220V□10% 50HZ/ 3~4.2kw
(Spindle motor):	(water cooling)40000rpm
(Transmission system) :	High precision stepping drive imported linear guide rail bearing imports

AUTOMATIC DOUBLE NEEDLE BELT LOOP MACHINE

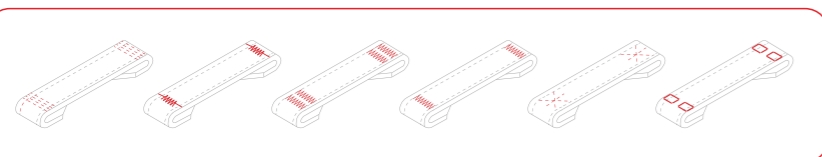
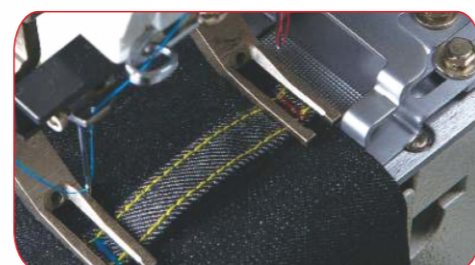

Standard belt loop line graph

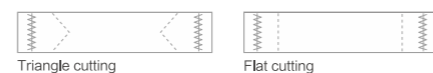

Triangle cutting Flat cutting

Cutting mode

V-T254-DNB

Capacity: About 5 pcs/minute

Product Overview:

- Automatic cutting / folding / feeding / tacking, one machine could replace 7 operators.
- 10 hours could produce 1800-2000 pairs of pants, 70% more efficiency than normal process.

V-T254-DNB
loop length 49-75mm

V-T254-DNB-L
It is longer belt loop, length 65-85mm

Model	Sewing speed	Belt width	Belt length	Voltage	Air pressure	Weight	Measurement
V-T254-DNB	2700rpm	7-20mm	49-75mm	220V	0.5Mpa 1.8L/min	200/245kg	128x123x155cm

BELT PULLEY FEED OFF THE ARM WITH AUTOMATIC TRIMMER FUNCTION



V-J928AT-RPL-S

Capacity: 3500rpm/minute

Product Overview:

- Economic type, with belt pulley and
- trimmer function. Could choose s
- eparate packaged

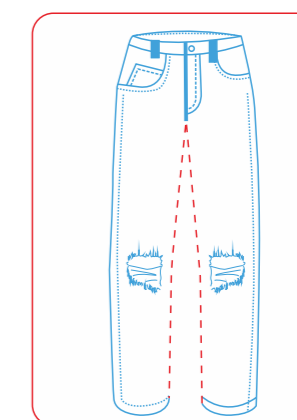

V-969ATS-RPL

Capacity: 5000rpm/minute

Product Overview:

- 5000rpm auto trimmer feed off the arm machine
- with belt pulley,with sensor recognize
- heavy cross point

Model	Speed	Needle	Power	Voltage	Air pressure	Weight	Measurement
V-928AT-RPL	4300rpm	TV5x5 #21	750W	220V	0.5Mpa	176/230kg	131x111x149.5cm
V-928AT-RPL-OR	4300rpm	Tvx64	750W	220V	0.5Mpa	100/113kg	117x82x118cm
V-968ATS-RPL	5000rpm	#21	750W	220V	0.5Mpa	176/230kg	131x111x149.5cm
V-J928AT-RPL	3500rpm	TV5x5 #21	750W	220V	0.5Mpa	176/230kg	131x111x149.5cm

AUTOMATIC POCKET SETTER



V-T3020ATP-AF

Full-auto iron-free pocket sewing machine
Capacity: 3 bags/minute

- With special round shape reinforcement function;
- Give more space for washing shrink;
- With quick change design device, mould cost reasonable;
- Step motor control fold feeding, more efficiency;
- With 3 piece free mould.

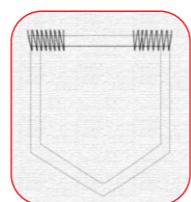

V-T3020ATPSL-7300A

Automatic pocket attach machine for jeans
Capacity: 6 pcs/minute

With Original Brother machine head, high class folding system quick change model. (include 4pcs quick change device)



HIGH SPEED COIN POCKET SETTER

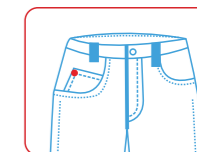

V-1002ATP

Capacity: 6 pcs/minute

Product Overview:

Speed depending on fabric, up to 3500RPM
Sewing area 50mm x 50mm to 170mm x 150mm
Moulds and sewing frame easy adjustable
Self explaining programming over touch screen
Can be used to do decorative stitching
Colour touch screen with I/O function
SMC Pneumatic valves / Cylinders

Powerful Panasonic X-Y motors
Laser lights for exact positioning
Stacker for finished pockets / Facings
Thread monitor in standard equipment
Programmable tension and pressure foot height
Sitting workstation

Output example :

Average pocket size : Up to 6,5 Pockets/min
Realistic output at factory : 3.400 pockets/10h

@100% efficiency rate (Double stitching)

Model	Speed	Needle	stitch length	Voltage	Air pressure	Weight	Measurement
V-T3020ATP	2800rpm	DPx17-#18	0.05~12.7mm	220V	0.5Mpa 1.8L/min	400/450kg	185x140x145cm

Model	Speed	Sewing area	Power	Voltage	Weight	Measurement
V-1002ATP	3500rpm	50x 50~170x150mm	750W	220V		

AUTOMATIC POCKET MOUTH CURLING MACHINE

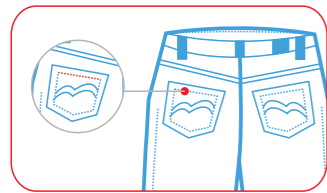

V-PMC-561DF

Automatic pocket mouth curling machine (interlock head)
Capacity: 260 pieces/hour

Product Overview:

- Option Kansai NL5803GPXP head;
- Folding size 7-25mm, control by step motor, could adjust automatic;
- Suitable for many kinds of material, elastic with good performance;
- Head movable, easy for maintenance.

Model	Sewing heads	Programmable folder size	Power	Voltage	Air pressure/Consumption	Weight	Dimensions LxWxH
V-PMC-561DF	3500rpm	50x 50-170x150mm	700W	220V-240V Mono 50/60 Hz	5.5Bar/30-45L/min	190KG	1345x1245x1260mm

AUTOMATIC TROUSERS BOTTOM HEMMING MACHINE



V-63900L/V-63900LC

Capacity: 4000rpm/minute

V-63900L Automatic trousers bottom hemming machine lockstitch

V-63900LC Automatic trousers bottom hemming machine lockstitch and chain stitch exchangeable

Product Overview:

- With upper-lower puller and needle feeding, make sure the joint stitches keep beautiful after sewing.
- Auto trimmer, presser foot lifter, sweep thread and curling folder.
- With reinforce function, after finish sewing with condense stitches prevent off thread. Width of hemming 12.7mm, perimeter of cylinder bed 23cm.

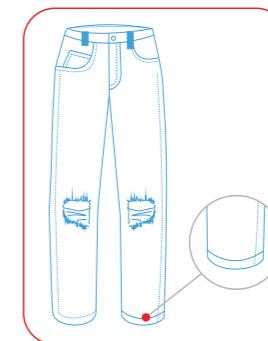

V-63900FAT

Full automatic trousers bottom hemming machine
Capacity: 4 pcs/minute

Product Overview:

- Full automatic sewing no need skillful workers;
- Big hook reduce the time for change bobbin;
- Maximum hemming width 30mm;
- Size adjustable, minimum diameter 14cm;
- 15s per piece (normal way 40 seconds), save 2 workers, save 2 machine.

Model	Speed	Needle	Needle quantity	Thread	Presser foot height	Weight	stitch length	Measurement
V-63900	3500	UY 180GVS	1	2	14	44/49kg	1-6mm	105x75x130cm
V-3022BHE	3500	DBx5	1	2	14	44/49kg	1-9mm	105x75x130cm
V-63900FAT	3500	DBx5	1	2	14	44/49kg	1-9mm	105x75x130cm

AUTOMATIC WAISTBAND SEWING MACHINE



V-1509P-WATC

Automatic waistband sewing machine
Capacity: 3 pcs/minute

Product Overview:

- KanSai original head KS-1509P;
- With auto cutting device, double pulley, And feed dog transport
- With skip stitch function for quickly produce second piece;
- Use 1/8 needle gauge, easy to adjust the request distance;
- With thread loss function;
- Around 25s per piece, normal way need 2 workers 2 machine take 80 seconds

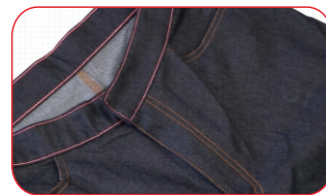

V-1104P-WATC

Automatic waistband sewing machine use original KanSai KS-1104P head, which is bearing construction for 1104P.
Capacity: 3 pcs/minute

Product Overview:

- Can use for heavy duty material.



Model	Speed	Needle	Power	Voltage	Air pressure	Weight	Measurement
V-1509P-WATC	4000rpm	DVx7	600W	220V	0.5Mpa	100/113kg	130x90x130cm
V-1104P-WATC	4000rpm	DVx7	600W	220V	0.5Mpa	100/113kg	130x90x130cm

AUTOMATIC SNAP BUTTON ATTACH MACHINE

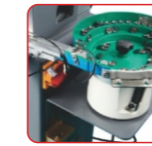

Adjustable rail



Mechanical feeding

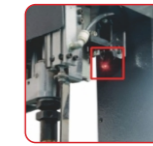

laser positioning

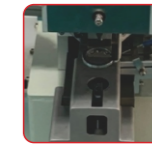

Continuous punching and punching device

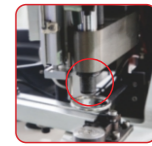

Universal mould

Advantage

- With high working efficiency, 40-60pcs per minute, 3-4 times faster than labor, other similar ones only around 30pcs per minute.
- Adopt the general mould of electric/pneumatic button attach machine, no need special mould. Also convenient to replace top & bottom mould, other brand only top mould easy to change.
- Use electric and touch screen interface, which is easy to operate.
- The punching mould has high durability and vibration reduction.
- According to the size of button, the width and height of track can be adjusted easily.
- Foot pedal controls feeding mechanism, feed up and down at the same time
- With laser positioning, more precise and safe to operate.
- When punching and riveting the buttons, moving back and front in a straight line to ensure the buttons are concentric.

Model	Voltage	Power	Air pressure	Net weight	Package
V-T818ATE-4	AC220V/50Hz	750W	3-6Pa	78KG	97x65x150CM

V-T818ATE-AB & T818ATE-CD (normally need 2 sets)

Automatic snap button attach machine
Capacity: 60 pieces/minute

Application: Suitable for all kinds of snap buttons.

A (top): Outer diameter: ϕ 12-20mm / Thickness: 1.5-5.0mm

C (bottom): Outer diameter: ϕ 9-11mm / Thickness: 0.2-1.5mm

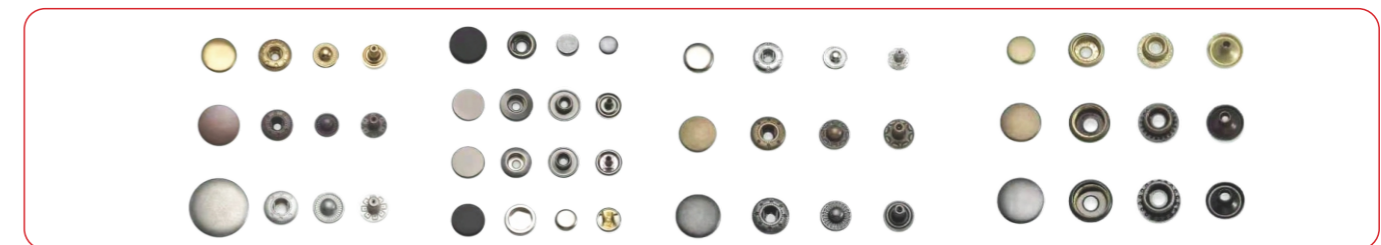

V-T818ATE

Auto jeans shake button attach machine
Capacity: 60 pieces/minute

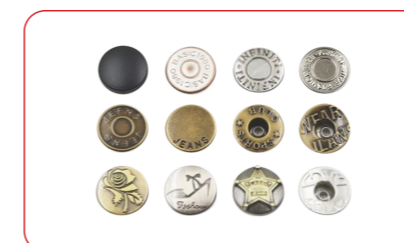

V-T818ATE-RV

Auto rivets button attach machine
Capacity: 60 pieces/minute



J-STITCH PATTERN SEWING MACHINE



V-T2210MJ-ASN

Capacity: 7 pcs/minute

Product Overview:

- For J-stitch on jeans / leisure trousers / uniforms, etc. Programmable by software for J-stitch pattern, which could match the different demands on different trousers.
- Automatic sewing for placket and tacking by one worker, each piece takes only 9 seconds, save 3 operator, each year could save 3 workers salary.

OPTION DOUBLE NEEDLE



Special design to avoid the error, full automatic high efficiency and stable

Model	Sewing speed	Sewing area	Stitch length	Presser foot height	Power	Air pressure	Weight	Measurement
V-T2210MJ-ASN	2700rpm	220x100mm	0.05~12.7mm	25mm	220V 550W	0.5Mpa 1.8L/min	220/280kg	122x122x132cm

AUTOMATIC OVERLOCK MACHINE

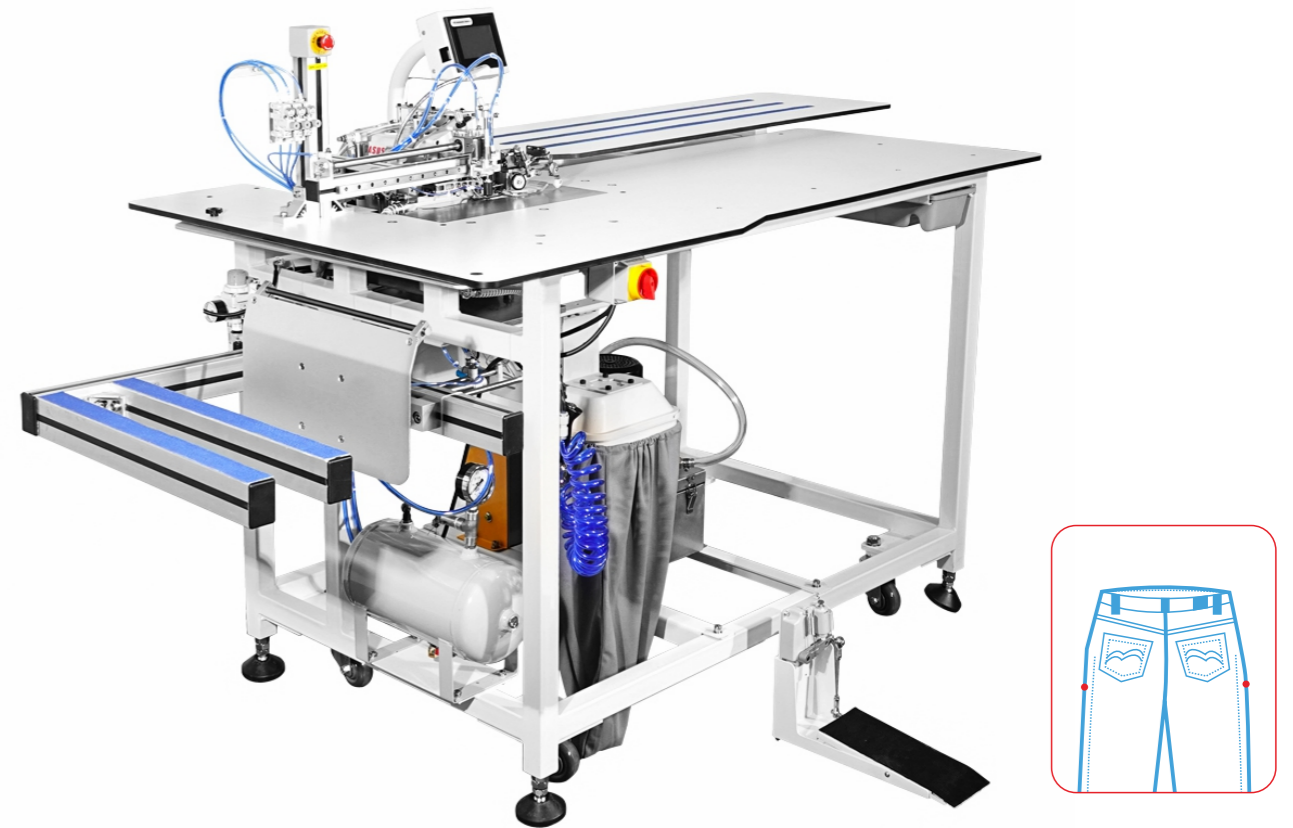

V-AO-3003B

Side seam serging for open seam style's

Capacity: 5 pcs/minute

Product Overview:

Denim/Chino front and back panels Sewing head Pegasus EX5214-03/333/TK(7500rpm Sewing head 2 needles / 4 threads Integrated Hoshing direct drive technology

Special fabric guide to avoid cutting fabric. The unit will detect and follow the trousers curve. Special thickness sensor for front pocket and back yoke. Stacker can stack long and/or short pants The unit can work in automatic mode, semi automatic mode and manual mode

Can work from top to bottom Can work from bottom to top

Can work both in combination

Easy programmable touch screen with I/O function

Dust and thread collector

Production capacity for normal length pants :

1 operator with 2 units :

16 seams/min = 4 trousers/minute

1 operator with 1 unit :

8 seams/min = 2 trousers / minute

Model	Speed	Power	Voltage	Weight	Measurement
V-AO-3003B	3500rpm	750W	220V		
V-AO-3005B	3500rpm	750W	220V		

SHIRT SLEEVE PLACKET MACHINE



V-T7300A-5009B

Capacity: 4 pcs/minute

Product Overview:

- Original Brother S7300A-303P head;
- With thread broken sensor, Panasonic 1000W motor;
- Stable plain stitch, each products less than 1mm difference, no need skillful workers;
- Suitable for both left & right sleeve placket making;
- Sewing area X: 3/4 7/8 1+1/8 1+1/4 1+1/2, Y: 200;
- 180pcs per hour, suggest one worker operate 2 machine, produce 360pcs/h, traditional way 2 workers only produce 80pcs/h;



Include placket creaser

Model	Sewing speed	Needle	Stitch length	Voltage	Air pressure	Weight	Measurement
V-T7300A-5009B	2500rpm	DBx1	0.1-6mm	220V	0.5Mpa	280/267kg	135x125x140cm

AUTOMATIC POCKET SETTER FOR SHIRTS / T-SHIRT



V-T9000ATP-QC

Quick change mould automatic pocket attached machine for knits and shirts, JUKI head

Capacity: 3 pcs/minute

Product Overview:

- High Sewing Efficiency
- Suitable for Different Pocket Styles
- Jig Quick to Change
- Laser Alignment and Automatic Folding Device
- Optional Eco-flexible Pocket Jig
- Powerful Control System

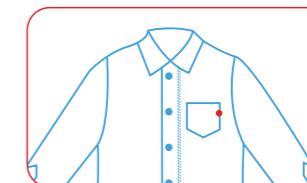

V-T8000ATP

With quick change mould device, Automatic pocket attach machine for shirts/T-shirts

Capacity: 5 pcs/minute

Product Overview:

- Original JUKI 8000A head;
- Auto-folding / feeding / sewing / stacking;
- 200-250 pairs / hour, improved 5 times efficiency;
- One time folding, no need pocket creasing;
- Suitable for different shape pocket, Sewing area 200mm*200mm;



Model	Electrical supply	Air pressure	Sewing speed	Sewing area	Stitch length	Pattern storage	Power	Needle type	Weight	Packing size
V-T7300ATP	AC220V,50/60HZ	0.6Mpa	3000r/min	25X21cm	0.1-20mm	999	3.5kw	DPX5	440/570kg	192X150X188cm

SHIRT BUTTON ATTACH & HOLING MACHINE

V-1903AT-MB06

Capacity: 3 pcs/minute

Product Overview:

- Automatic buttonhole indexer for ladies' and men's wear
- Feed direction can be changed (right feeding for men's wear) (left feeding for ladies wear)
- The garment can be positioned on the feeding table during the previous garment is in process
- This overlapping feeding device decrease the operation time with 5 seconds/garment
- One operator can operate up to 3 machines, with 2 sets, 200% production, with 3 machines 280% production (Approx)
- The machine can stitch 1 to 20buttonholes, and store 999 patterns in the memory
- High precision servo motor feeding between buttonholes
- Laser lights for correct positioning of the garment
- Sub clamping device to prevent deviation of the material at the time of delivery the garment to the sewing area
- I/O page for easy actioning of outputs, and positioning of sensors
- Thread monitor for thread end and eventual thread breakage
- Genuine SMC for all standard pneumatic parts
- No skilled operators required for this operation

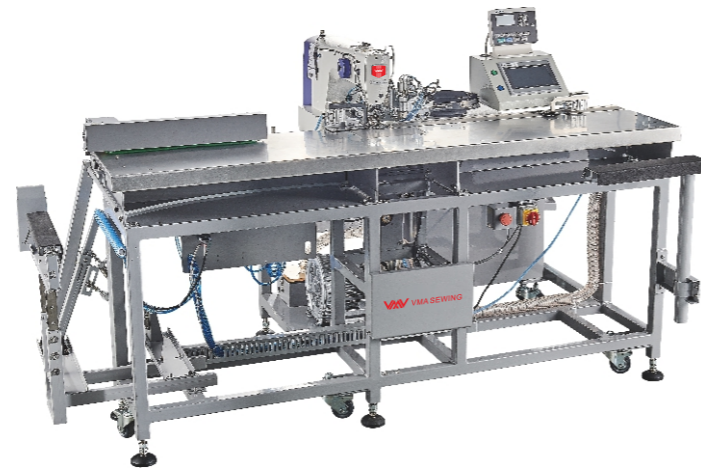
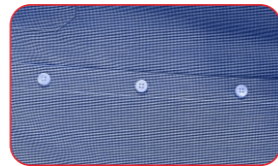

V-1795FAT-MB03

Full automatic button holing machine

Capacity: 4 pcs/minute

Product Overview:

- The unit is equipped with the IMB-6002A pneumatic button feeder system for all kind of buttons
- Distance between buttons are perfectly programmable over color touch screen
- This overlapping feeding device decrease the operation time with 5 seconds/garment
- Feeding direction is to the right(Only right hand side panels)
- After the button attaching the garment will be transported to the stacker
- 2-3 units can be operated by 1 operator, as well in combination with the buttonhole unit(MB6003A)
- Tip: 2x button hole indexer and 1 Button indexer is a good combination
- High precision servo motor feeding between buttons
- Laser light for correct positioning of the garment
- Data can be quickly transferred between different machines by USB or SD-Card
- I/O page for easy actioning of outputs, and positioning of sensors
- Thread monitor for thread end and eventual thread breakage
- Panasonic X drive and motor
- Genuine SMC for all standard pneumatic parts
- No skilled operators required for this operation

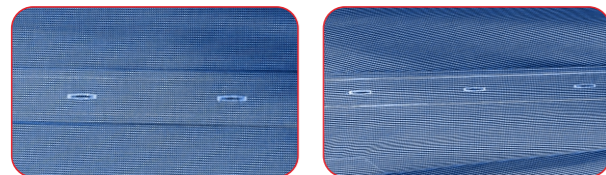

VMA SEWING

AUTOMATIC T-SHIRT BOTTOM HEMMING MACHINE

V-W500APW-BHR

Capacity: One person operates two set, 6-8 pieces per minute

Product Overview:

- Suitable for adult tubular T-shirt bottom hemming, with automatic guide system, one worker could operate 2 sets machine, each hour could produce around 360pcs by 2 machine 1 operator.
- Choose size and adjust size through control panel, T-shirt perimeter maximum 160cm, minimum perimeter 80cm; the hemming width between 15~25mm.
- Original Japanese interlock machine, with high quality servo motor and electronic components, could joint the start stitches and end stitches perfectly.
- With high technology stacker to make sure after trimmer collect cloth correctly.
- Suitable for most kind of cotton material, cotton with some polyester fiber, cotton with some Viscose, cotton with some modal or other kinds of material. (very special material or very special design may not suitable)

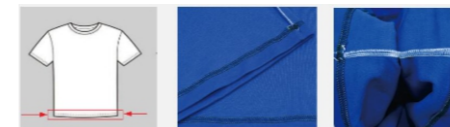

VMA SEWING



V-W500APW-BHF

Automatic flat design hemming machine
For Sleeves or single piece bottom sewing
Capacity: 6-8 pieces/minute



Model	Sewing speed	Stitch length	Voltage	Air pressure	Weight	Measurement
V-W500APW-BHR	4000rpm	1.5-5mm	220V 50/60Hz	0.6Mpa	340/370kg	147x117x148cm
V-W500APW-BHF	4000rpm	1.5-5mm	220V 50/60Hz	0.6Mpa	500/550kg	232x127x148cm

AUTOMATIC PLACKET SETTING MACHINE FOR POLO T-SHIRT



V-T5878-58N

Capacity: 4 pieces/minute

Product Overview:

- 3~8 seconds produce one piece; around 2000 piece each 10 hours working.
- Suitable for most Male & Femal polo T-shirt.
- Machine head is Original from Japan, with Semi-oil electronic lockstitch, Panasonic servo motor, Japanese control system, Germany Schneider electronic components, SMC cylinder, all parts are high quality.
- Independent motor control make sure the cutting precise and beautiful.
- Control panel very easy and simple for operation, with infrared laser positioning system, with thread broken sensor, with automatic stacker collect material.

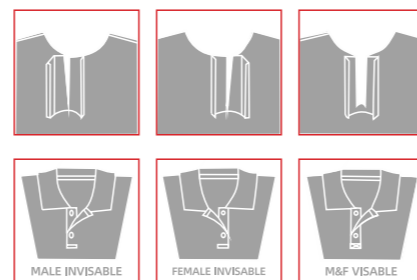

Model	Needle	Accuracy	Sewing speed	Sewing width	Sewing length	Voltage	Air pressure	Weight	Measurement
V-T5878-58N	DBx1 9# 11# 12# 14#	± 0.02mm	3600rpm	60mm	360mm	220V 50/60Hz	0.6Mpa	266/342kg	146x105x138cm

PANTS POCKET FACING UNIT

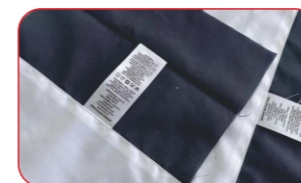

V-5016A-9000C

Automatic pocket Facing Unit For Suit Pants

Capacity: 5 pcs/minute

Product Overview:

Sewing head Juki 9000C lockstitch (4500 RPM)
 Sewing unit to stitch straight "folded" facings on pocket pouches with good stitching quality and excellent edging distance
 Different top stitch width can be adjusted by an efficient folding device. The software can be set to stitch on the total length of the pocket pouch (sensor), as well only sewing on the length of the facing
 The unit can be use on front or back pocket pouches-adjustment sewing widths
 No skilled operators
 Freely programmable over touch screen Back-tack or stitch condensing programmable label can be added as per needs stitch length from 0,5 to 5mm
 Production : Up to 550 pocket facings / 1 hour

Sewing Unit Type	Capacity in 1h	Sewing Head	Speed	Stitch length	Voltage	Power	Air pressure / Consumption	Dimensions packed mm LxWxH	Weight Kg	Weight packed
V-5016A-9000C	550	Juki DDL9000	4500 RPM	0.5 - 5 mm	220V - 240V Mono 50/60 Hz	1,20Kw	6Bar / 15L/min	1820x1220x1420	150Kg	180Kg

AUTOMATIC POCKET LASER OPENER



V-1008ATP-2T

Capacity: 10-15 minutes/pcs

Product Overview:

The pocket opener is suitable for real bags, fake bags, T-shirt placket, especially the zipper of sports pants, which can be completed at one time, which is three times of the ordinary bag opener.

The folding mechanism of the automatic non-iron folding bag machine adopts the cylinder automatic folding technology, which improves the production efficiency and saves labor by eliminating the need for ironing table for folding pockets.

The automatic shrinkage mechanism of the internal pressure frame makes the change of the pocket's edge trace not limited. The internal pressure frame adds the function of replaceable adjustment.

Automatic feeding mechanism, after machine sewing, the automatic manipulator is used for feeding, and the sewing products can be placed neatly.



Head sewing speed	3000sti/min
Equipped with handpiece	311(HS)
Machine needle	mt*190(12#, 14#, 16#)
Sewing stitch programming	input mode of operation screen
Line programming storage capacity	Up to 999 kinds of patterns can be stored
Stitch distance	1.0mm-3.5mm
Pressure foot rising height	60mm-80mm
Sewing pocket range	X direction 100mm-220mm Y direction 12mm-30mm
Speed of sewing pockets	10-15 seconds per second
Folding method	Folding bags in four directions at the same time Cutting with 100W laser head
Pocket opening	Bag folding and sewing are carried out at the same time,
Sewing methods	with protective function of broken thread
Feeding drive mode	Taiwan DELTA servo motor drive (750w)
Power supply	AC220V
Air pressure and air pressure consumption	0.5Mpa(5kg/cm ²), 22dm ³ /min
Weight	650kg

AUTOMATIC POCKET WELTING MACHINE FOR PANTS

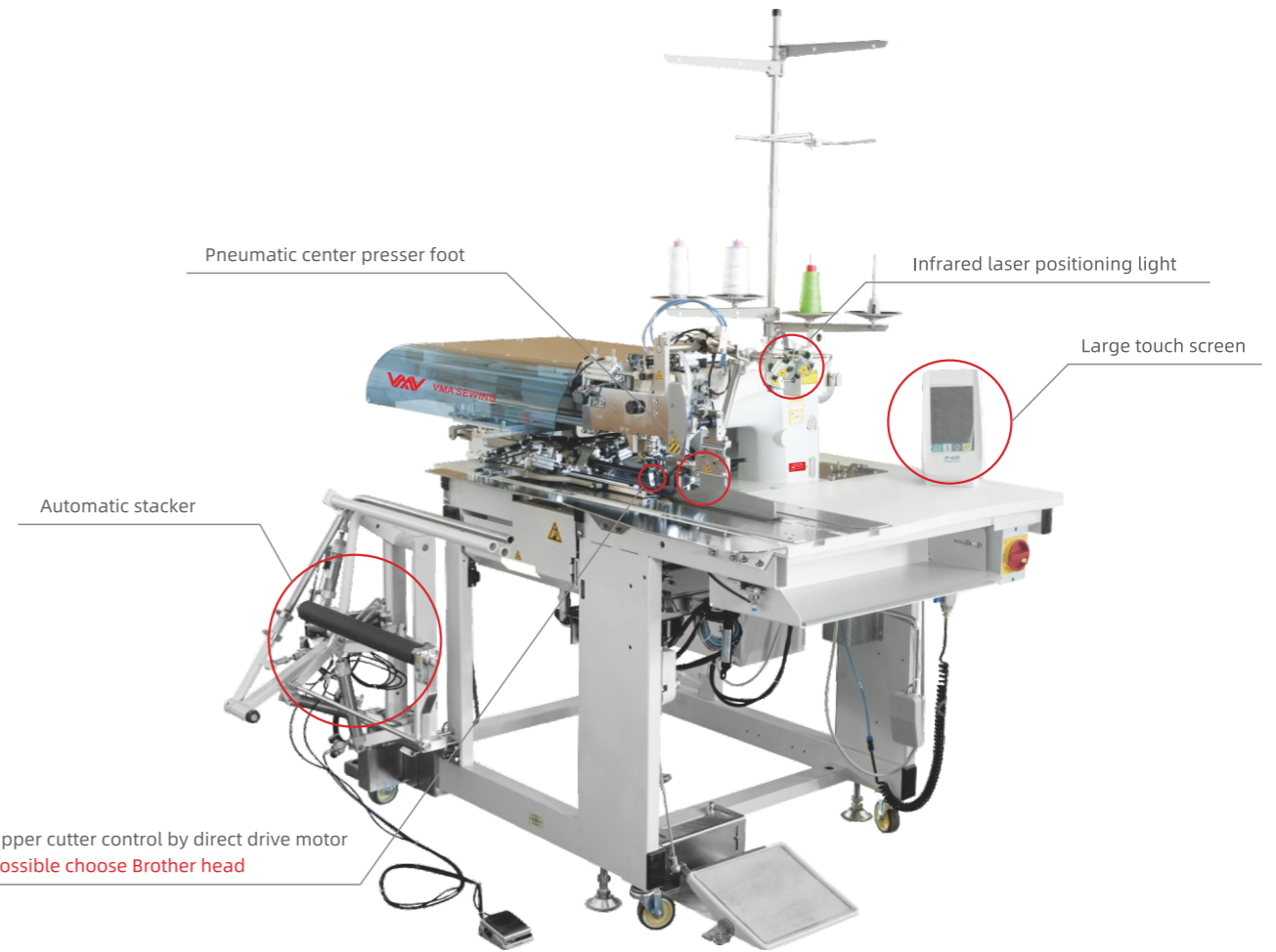

V-T5878-28F

Capacity: Normal length 140mm, 5 pcs/minute

Product Overview:

- Suitable for straight pockets on suits/ jacket/ pants (could add flap), sewing length between 35mm~220mm.
- Easy change the design from single welt to be double welt: change the pad of center presser foot and then press one key on control panel to change all the parameters automatic.
- Upper cutting system control by direct drive motor more efficiency, save energy, reduce noise and vibration.



V-T5878-28B

V-T5878-38B AUTOMATIC POCKET WELTING MACHINE FOR SLANT POCKET DESIGN

Model	Needle	Needle gauge	Stitch length	Sewing speed	Sewing length	Condensation stitching	Back-tacking	Voltage	Air pressure	Weight	Measurement
V-T5878-28F	DPx17	10mm / 12mm (options: 14 16 18 20mm)	Standard 2.5mm (2-3.4mm)	3000rpm	35MM-220MM	Standard 1.0mm (0.5-1.5mm)	Standard 2.0mm (0.5-1.5mm)	220V 50/60Hz	0.5Mpa	300/350kg	160x90x160cm

DART & PLEATS SEWING UNIT FOR SUIT PANTS



V-5015A-9000C

Capacity: 8 pcs/minute

Dart & pleats sewing unit

- Step motor controlled feeding device to ensure equal quality on dart or pleat
- Different fabrics can be sewn with the unit
- Easy handling feed in platform
- No need skilled operators for this unit, very short learning time
- Easy programmable darts or pleats, only 1 time programming the needs, then store for eventual later use
- Clamping table to clamp trouser bundle, waterfall system
- No need moulds or parts changing for pleats or darts, the machine works with a X-Y system, Lcd touch screen
- Needles grab the fabric after feeding, so the fabric position always correct and equal
- Darts are sewing from top to the point, to ensure no dimples on the fabric
- With thread broken sensor
- Height adjustable frame
- Cycle programming possible for different dart / pleats in the same trouser
- SMC cylinder
- Panasonic servo drive to control highly accurate stitch length
- Backtack function freely programmable

Sewing Unit Type	Capacity in 1h	Dart/Pleat Lengths	Dart/Pleat Width	Sewing Head	Speed	Stitch length	Voltage	Power	Air pressure / Consumption	Dimensions mm LxWxH	Weight Kg	Dimensions packed mm LxWxH	Weight packed
V-5015A-9000C	625 - 750 darts/pleats	10 - 250 mm	4 - 40mm	Juki DDL9000	4500 RPM	0.5 - 5 mm	220V - 240V Mono 50/60 Hz	1,20Kw	6Bar / 15L/min	1100x800x1300	170Kg	1270x890x1450	210Kg

AUTOMATIC BUTTON WRAPPING MACHINE



V-289RK

Capacity: 6-7 pcs/minute

Product Overview:

- The machine has high productivity, intended for men's and ladies' coats/suits/uniform etc. Easy to change different types of buttons to be sewn, such as flat buttons, shank button, covered button and snap fastener.
- The machine could loading two moulds at a time, more efficiency for sewing & wrapping 2 buttons.
- Each machine come with 24 kinds of button moulds



V-438-289
Button wrapping & knotting machine



V-12P
Button wrapping & knotting machine



V-12R
Automatic hot melt wrapping & knotting machine

Model	Wrapping speed	Sewing speed	Needle	Distance between button holes	Voltage	Weight	Measurement
V-289RK	1800rpm	1200rpm	SMX332EXTLG-NY (#12-18)	1.5-6mm	220V	280/267kg	135x125x140cm

HAND STITCH SERIES

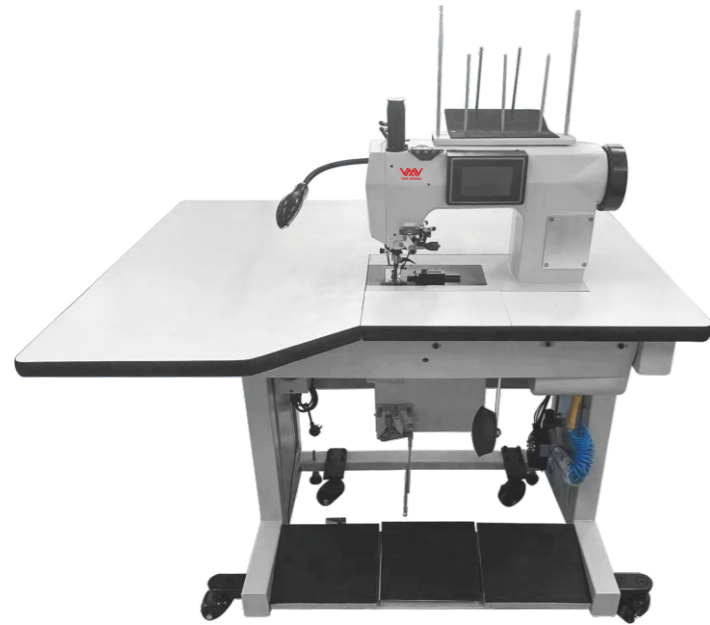

V-T588E

Computerized hand stitch machine

Product Overview:

- easy to adjust the size of Bead-point and stitch length , could also keep the top and bottom even and precise.
- With half stitch button to short the rest length of thread, with positioning device make sewing easier.



V-T798E

Computerized hand stitch machine

Product Overview:

The machine is used for decorative hand stitching as well as reinforce stitching on the garment, special model for shirt. It is suitable for various fabric thicknesses.



Model	Needle	Thread	stitch width	stitch length	presser foot neigh	Sewing speed	Weight	Measurement
V-T588	750C 16-23#	1	90mm	0.5-6mm	220V	420-500rpm	191/225kg	1280x960x860cm

SUITS MACHINE

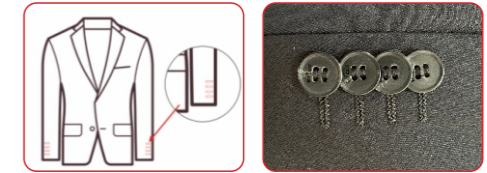

V-6000D

Imitation button holing machine
Capacity: 30 pcs/hour

Product Overview:

- Programmable parameters, such as stitch length, button hole length & width.
- Automatic adjust buttonholes quantity, and distance of two holes.
- LCD touch screen, with needle position function.
- With 20 patterns, Speed 1500-3500rpm, EBx750 14#16# needle, 550W motor, 0.6Mpa air, 220V 50HZ.

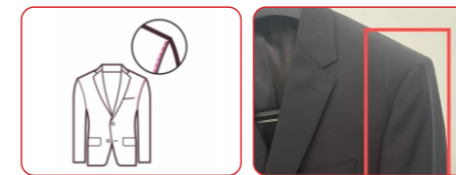

V-T560A

Computerized sleeve setting machine
Capacity: 15 pieces/hour

Product Overview:

- Top feeding control by 2 step motor.
- LCD screen could record 100 designs.
- With curve arm hole guiding function.
- Could setting separate segment for wrinkle value .
- Could adjust a little wrinkle value by pedal.
- With 100 patterns, Speed 4000rpm, needle 134-35 DPx36 9-16#, stitch length 1.5-5.5mm, needle stroke 41mm, presser foot lifter amount 8mm, 2 threads, 750W motor, 0.5Mpa air, 220V 50HZ.



AUTOMATIC ELASTIC RIBBON SPLICING MACHINE



V-T1008G-09XJ

Capacity: about 5000pcs in 10 hours

Product Overview:

- Automatic feeding / cutting / sewing / collecting by one button;
- One worker could operate 6 machine; each machine could produce around 5000pcs in 10 hours.
- Have 2 ways to splicing elastic, named overlapping and butt;
- Splicing length is 200~999mm; Splicing width is 6~60mm;
- Automatic stop when run out of the ribbon or detect the ribbon knot;
- Easy to adjust ribbon size, only need adjust the tightening screw wheel.

V-T1007G-10XJ: Could read logo automatic, ensure the absolute middle position between logo and splicing place, which is more efficiency, and could splicing one big size and one small size ribbon. With special collecting device, which has 3 bars, each one collect 200pcs material, totally 600pcs at a time.

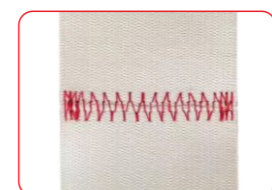

Graphic visual identification system Collecting device

Model	Sewing speed	Sewing area	Power	Air pressure	Weight	Measurement
V-T1008G-09XJ	2700rpm	100x70mm	220V 550W	0.5Mpa 1.8L/min	230/260kg	125x93x133cm

AUTOMATIC STRING THRUSTING MACHINE FOR SPORTS WEAR



V-F6021AST high class

Capacity: 6 pcs/minute

It is suitable for the threading process of flat buttonholes, bird-eye embroidery holes, metal air hole such as sports pants, hoodies, zipper hoodies etc. Machine integrate processes into one step, reducing the labor intensity and improving the efficiency. It takes about 10-14 seconds to finish the rope inserting process.

Performance advantage

Multiple function: One button switch of 2 modes, available for sports

Patent technology

pants or hoodies rope inserting process.

Inserting mode: Semi-automatic or full automatic one-key switch. Switch mode: Hand switch or foot switch can be switched by customer needs.

Speed: Inserting speed could adjust by the touch screen depend on the customer's request. Patent technology

Expansion mechanism: It can be rotated by 90 degrees. The lifting height can also be adjusted to adapt to different people.

Expansion plate: The operating angle can be adjusted by 90 degrees and free support the special jig for zipper hoodies.



V-T6021AST Economic class

Capacity: 10-15 seconds/piece

Model	V-F6021AST
Pants diameter	Φ191mm-Φ445
Cap diameter	Φ116mm-Φ121mm
Cord hole type	Flat buttonhole > 8mm; bird eye embroidery hole > 5mm, metal air hole > 5mm
String diameter	Round rope: 5mm-6mm Flat rope: 5mm-9mm
Pressure	0.5Mpa、0.5L/min
Power Supply	单相200-240V Single phase 200-240V
Power	600W
GW/NW	200kg/280kg
Product specification	L: 1170mm*W:520mm*H1087mm(The width of folding platform after opening is 922mm)
Packing size	L: 1500mm*W:600mm*H1300mm

LEFT HAND SEWING MACHINE



HIGH SPEED ZIGZAG MACHINE



V-L998DAT-2G-R

One set left hand EX direct drive overlock with one set normal EX direct drive overlock 4 thread, for sewing the two side of the edge, with feeding device together

Product Overview:

While the left and right sides of fabric sewn for Simmons, mattresses, cleaning cloths, scarves and other decorative sewing both sides. The operation speed is dramatically improved. Sewing time is reduced to a minimum fault, sewing high-quality products, sewing material clean and beautiful stitches.

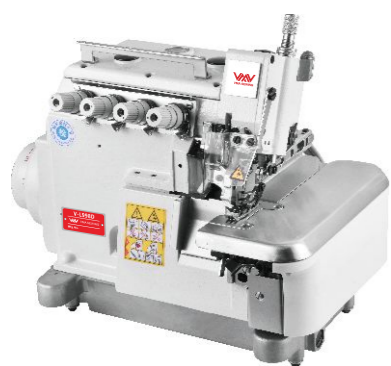

V-L998D

Left hand high speed automatic overlock



V-L998TD

Direct drive high speed reverse overlock Sewing machine



V-L998E-4

Left hand high speed automatic overlock 4 thread, with trimmer & presser foot lifter



V-L7300

Direct drive high speed Farverse lockstitch machine



V-L500D

Direct drive high speed matbed Reverse interlock sewing machine



V-L008VCD

Direct driei msm-zeedisewing mschime



V-2284 ZIGZAG

(1 step 2 points & 3 step 4 points)

MECHANICAL

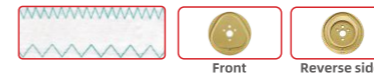

V-2284D-7/P ZIGZAG

ZIGZAG (1 step 2 points & 3 step 4 points)

ELECTRONIC

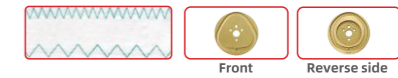

V-2290SS-7

Computerized ZIGZAG machine single step motor



V-2290SR-7

Computerized ZIGZAG machine double step motor

Model	Needle	Trimmer	Needle position	Zigzag width	Auto foot lifter	Presser foot height	Speed	Weight	Measurement
V-2284D	DPx5 10-14 #			10mm		5.5-10	4500rpm	39/47kg	66x35x62cm
V-2284D-7/P	DPx5 10-14 #	○	○	10mm		5.5-10	4500rpm	39/47kg	66x35x62cm
V-2280D-7/P	DPx5 10-14 #	○	○	10mm	○	5.5-10	4500rpm	39/47kg	66x35x62cm

Name of pattern	Straight stitch	Basic zigzag	2 step zigzag	3 step zigzag	Scallop(left)				Scallop(right)				Blind stitch (left)	Blind stitch (right)	Custom pattern	
					Standard	Crescent	Equal-width	Equal-width	Standard	Crescent	Equal-width	Equal-width				
Stitch patterns																
Number of stitch	1	2	4	6	24				12				24	12	2+α	maximum 500

ZIGZAG SEWING MACHINE



V-20U53E

ZIGZAG computerized with 190 designs



V-20U93E

Auto lubrication ZIGZAG computerized with 190 designs



V-20U43D

ZIGZAG simple direct drive



V-20U53D

ZIGZAG simple direct drive



V-20U93D

ZIGZAG simple direct drive auto lubrication



V-20U43

ZIGZAG conventional



V-20U53

ZIGZAG conventional



V-20U63

ZIGZAG conventional



V-457A

ZIGZAG 3 step 4 points

Model	Needle	Thread	Stitch length	Presser foot height	Zigzag width	Speed	Weight	Measurement
V-20U43	Dpx5 14-16 #	2	5mm	6-12mm	12mm	2000rpm	20/28kg	56x26x44.5cm
V-20U53	DPx5 14-16 #	2	5mm	6-12mm	8mm	2000rpm	20/28kg	56x26x44.5cm
V-T457A	DPx5 14-16 #	2	5mm	6-9mm	8mm	1600rpm	20/28kg	56x26x44.5cm
V-T20U53D	DPx5 14-16 #	2	5mm	6-12mm	8mm	1800rpm	20/28kg	56x26x44.5cm

ZIGZAG SEWING MACHINE



V-20U53DB

Big hook bigger body direct drive zigzag machine(1530 series)



V-20U53DB-S

Big hook bigger body direct drive zigzag machine with 190 designs



V-20U53DB-SS

Big hook bigger body direct drive zigzag machine with double step motor 240 designs



V-20U53DB-AT

Auto trimmer zigzag sewing machine.



V-20U53AT-S

Big hook bigger body auto trimmer zigzag machine with 190 designs



V-20V53DH

Top and bottom feed big hook ZIGZAG machine direct drive



V-20U73D/V-20U73DB

Cylinder bed direct drive zigzag machine/big hook



V-2150H

Post bed zigzag machine, single needle, 3 step 4 point



V-8530D

Direct drive feed off the arm zigzag machine

Model	Needle	Thread	Stitch length	Presser foot height	Zigzag width	Speed	Weight
V-T20U53DB	DPx5	2	5mm	8-12mm	8mm	2500	20/28
V-20U53H	DPx17	2	6mm	8-13mm	0-9mm	2000	35/41

BLIND STITCH MACHINE



HAND STITCH & MATERIAL SPLITTING MACHINE



V-T500
Desktop blind stitch machine



V-T500-1
Desktop blind stitch with skip function



V-T511D
Industrial blind stitch machine



V-T511E
Direct drive blind stitch machine
medium & heavy material



V-360-BD
Direct drive blind stitch machine
heavy duty material



V-364-BD
Direct drive blind stitch machine
transport differential



V-370-BD
Direct drive loop blind stitch
width could adjust



V-860
Loop blind stitch



V-1190
Double side blind stitch machine



V-1430
Blind stitch with special pulley
for diving/surfing cloth



V-357-BD
Direct drive blind stitch with pulley for
trousers waist sewing



V-160-20
Semi-automatic blind stitch tacking machine



V-T641EP
Blind stitch with pneumatic trimmer function



V-T641-2A
Blind stitch flat head, manual lubrication for
common cloth, sweater, hats etc.



V-T641-6B
Blind stitch cylinder bed, auto lubrication
for gloves, socks etc.



V-T388D
Simple direct drive hand stitch machine



V-T388
Mechanical hand stitch machine

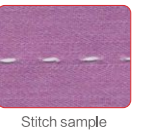

Stitch sample



V-103-3
Clothing cutting machine



V-PF130A
Double face cashmere splitting machine, automatic adjust knife,
130mm size knife, servo motor, cutting width
1.1-15mm, 2000-11000rpm, 550W 220V.

Model	Needle	Thread	Stitch length	Presser foot height	Zigzag width	Speed	Weight	Measurement
V-T388	DPx5 16-20#	1	5-8	5mm	2/3/4/5	1000rpm	29.5/36.5kg	59x23x55cm

BAG CLOSER MACHINE



V-T26-1A
Single needle



V-T26-2A
Double needle



V-T26-22
Single needle double line



V-T26-1S
With folder for cover the edge



V-GK-9-12BB
With battery no need cable during work



V-GK-9-12
New design



V-GK-9
Manual lubrication



V-T26-1A-ATF
With sideslip plate for transport



V-T109
Small carpet overlock machine

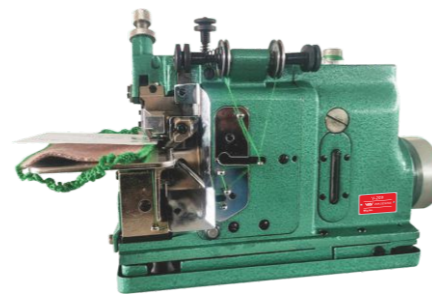

V-209
Arm logo machine

HEAVY DUTY BAG CLOSER MACHINE



V-GN20-2
Sacks close machine



V-GN20-2A
Two thread carpet closer machine



V-GN20-2B
Container bag closer



V-GN20-3A
Three thread Carpet closer machine



V-GN20-3
Net rope machine



V-GN20-6
Net rope joint machine with guiding device



V-GK35-2C
with auto-trimmer
duole thread big closer machine



V-2502K
Carpet machine with knife



V-T2200
Whisker edge overlock machine

Model	Stitch length	Thread	Needle	Speed	Voltage	Weight	Measurement
V-T26-1A	6.5mm	1	DNx1 25#	1250rpm	110/220V	5.6/8.0kg	40x27x37cm
V-GK-9	5mm	1	BCx5 25#	800rpm	220V	4.5/6.0kg	33x27x16cm

Model	Stitch length	Thread	Needle	Speed	Voltage	Weight	Measurement
V-GK35-2C	6.5-11mm	2	80800x250#	2000rpm	110/220V	25/30kg	40x27x37cm
V-T2502	1-10mm	4	7714 3/20	2500rpm	220V	38/42kg	33x27x16cm



V-T20S

Desktop sewing thread distributor machine double thread



V-T30P

Desktop thread distributor machine, double head, for both sewing and embroidery thread



V-T10S

Desktop new design thread distributor machine single thread



V-T20C

Desktop embroidery thread distributor machine double thread



V-T40S

Desktop embroidery thread distributor machine four thread

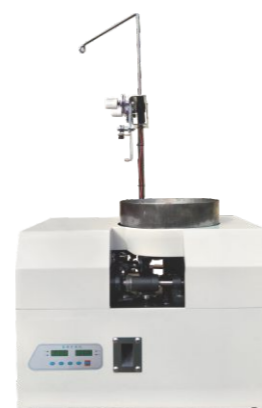

V-T0SAT

Automatic bobbin winder machine

Model	Thread	Voltage	Weight	Measurement
V-T20S	2	110/220V	14/16.5kg	50x30x35.5cm
V-T40S	4	110/220V	18/20kg	71x50x33cm

V-DJ01

Plastic staple machine

- Automatic injection staple pin;
- 0.5s quick binding;
- 12mm binding thickness
- 13mm staple pin;
- High quality steel needle, precise positioning

Power	220V/50Hz
Rated power	60W
Thickness range	≤12mm
Staple size	13mm
Tagging speed	0.5s
Net weight	19kg
Suitable fastener	staple pin



Tag pin



V-SK01

Pneumatic slipknot nailing machine, special for socks / gloves / underwear



Model	Needle	Sweing Width	Maximum foot lift distance	Gas Source	Power
V-SK01	TVx5	10mm	30mm	0. 4-0.7mpa	220V/50HZ

SNAP BUTTON ATTACH MACHINE



V-T818FT

Servo motor snap button attach machine

Advantage

- With safety protection device, avoid hurt worker's finger.
- Adopt servo motor, save more than 80% power
- Wide range voltage 180-240v
- Less vibration, quiet produce.
- High speed, high precision, improve production efficient and quality greatly

Power consumption

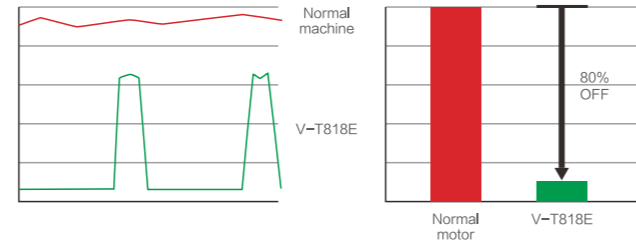

Model	Power	Voltage	Motor speed	Stroke(mm)	Weight	Measurement
V-T818S	750w	180-240v	5000rpm	40	18/25kg	36x33x54cm



V-T818EN

New design servo button machine without oil



V-T818S

Servo motor button attach



V-T818DN-3

Servo button attach 3 heads



V-T818

Mechanical big button attach



V-818PS

Mechanical big button attach



V-T818P

Pneumatic button attach



V-T818P-3

Pneumatic button attach 3 heads



V-T818PA-3

Pneumatic button attach 3 heads with electronic panel



V-T818P-12

Pneumatic button attach 12 heads

Model	Pressure	efficiency	Protection	Positioning	Air pressure	Voltage	Weight	Measurement
V-T818P-12	150-650kg	32 times/min	Bumper	Laser light	0.15-0.8Mpa	220V	45/48kg	42x34x46cm

PEARL & BEADS MACHINE



V-T818AT-2PS4

Automatic special shape & pearl beads plastic button attach machine



V-T818AT-PT4

Automatic threaded nails plastic button attach machine match with 4 claws nail base button



V-T818AT-PE4

Automatic pearl beads & plastic button attach machine match with 4 claws nail base button



V-H300T

Semi auto double plates hotfix rhinestone machine

Model	Power	Voltage	Weight	Measurement
V-T818AT-2PS4	840W	220V	140/160kg	95.5x75.5x138cm
V-T818AT-PE4	750W	220V	90/110kg	75x70x118cm
V-T818AT-PT4	840W	220V	120/140kg	70x68x134cm

CYLINDER BED MULTI-NEEDLE SERIES

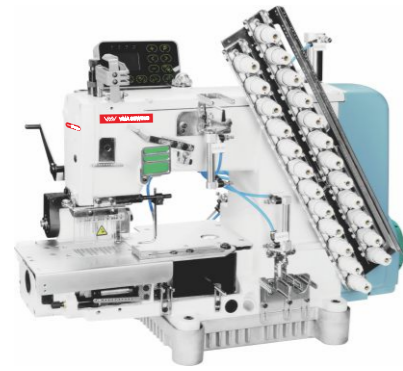

4000 RPM

V-007EF-12064P

4000 rpm thread trimming integrated control box buildin multi-needle machine

Product Overview:

Fashion and simple one-piece design, computer control can freely set various sewing parameters High efficiency, small vibration, easy and comfortable operation, optimized automatic thread trimming mechanism, multiple needle positions are optional, (4 needles, 8 needles, 12 needles, 19 needles Needle) to improve the quality and efficiency of garment enterprises.



V-008VCD-33048P-VPQ/VSM

33-needle direct-drive single rubber band stitching

Product Overview:

It is changed from 16 flower trays, using the combination of needles and threads to sew dozens of different patterns. It is suitable for decorative sewing of bedding such as high end clothing, curtains, bedspreads, and flower decoration sewing of tablecloths or interior decorations.

CYLINDER BED MULTI-NEEDLE SERIES

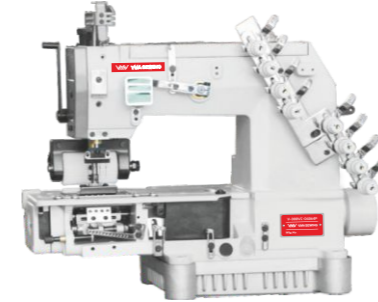

V-008VC-04064P

Four needles machine

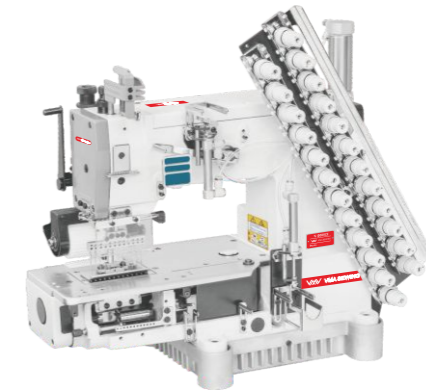

V-008VCE-12064P

Multi-needle cylinder bed with auto trimmer

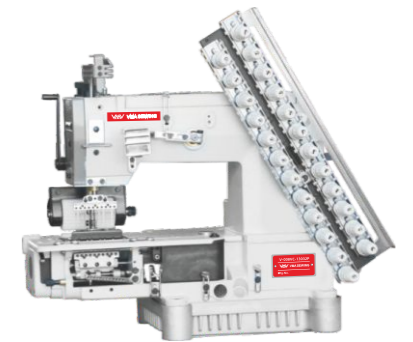

V-008VC-13032P

Thirteen needles machine

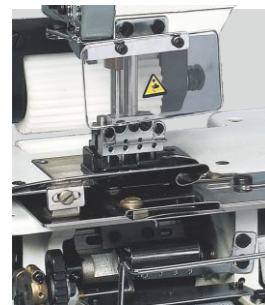

VWL: Front elastic belt feed roller device

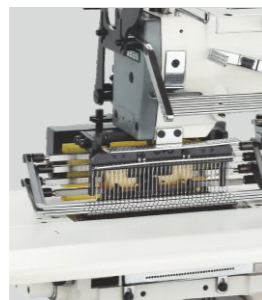

VSM: Wrapping Device

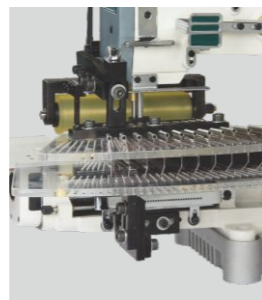

VPT: Folding and sewing device

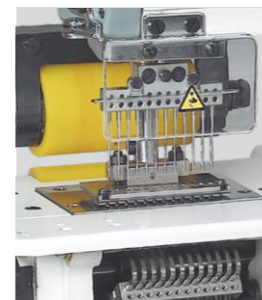

VPQ: Stretch line draw and crease device



V-008VCD-12064VSQ

Direct drive 12 needles with presser foot lifter for elastic thread



V-008VC-12064VPS

Twelve needles with shirring device

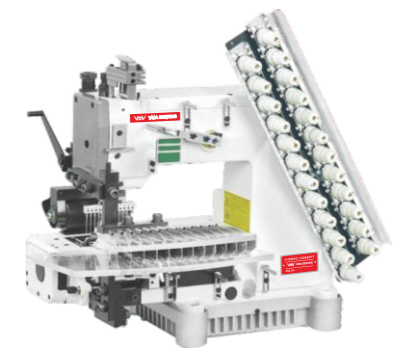

V-008VC-12064VPT

Twelve needles for shirt pin-tucking

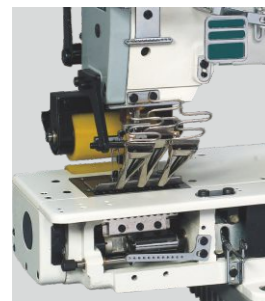

VPL: Tape applicator



VSF: Placket Sewing Device

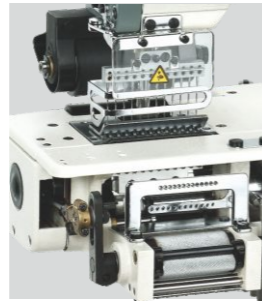

PQ: The middle expansion line draw and fold seam device

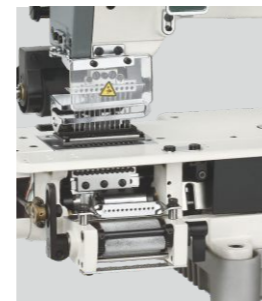

VSQ: Bottom stretch line draw and crease device



V-008VC-04064VWL

Four needles with metering device for waist



V-008VC-04064VSF

Four needles for shirt front sewing

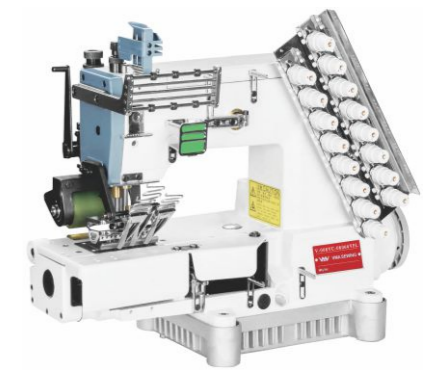

V-008VC-08064VPL

Eight needles for tape attaching

FLAT BED MULTI-NEEDLE SERIES



V-1404P
Four needles machine



V-1406P
Six needles machine



V-1412P
Twelve needles machine



V-1413P
Thirteen needles machine



V-1417P
Seventeen needles machine



V-1404PMD
Four needles with metering device for waist



V-1404PSF
Four needles for shirt front sewing



V-1408PL
Eight needles for tape attaching



V-1412PQ
Twelve needles for simultaneous shirring
middle thread is elastic



V-1012PS
Twelve needles with shirring device



V-1412PTV
Twelve needles for shirt-tucking

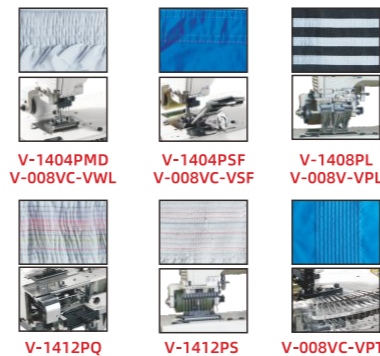

V-1404PMD
V-008VC-VWL

V-1404PSF
V-008VC-VSF

V-1408PL
V-008V-VPL

V-1412PQ

V-1412PS

V-008VC-VPT

FLAT BED SPECIAL MULTI-NEEDLE MACHINE



V-1508P
Four needles for waistband



V-1509P
Six needles for waistband

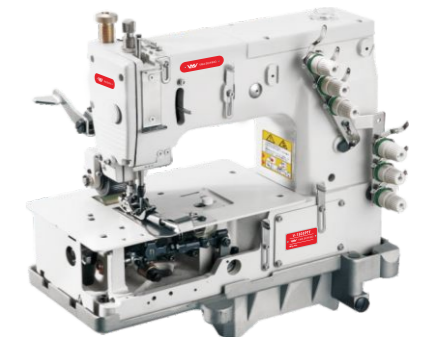

V-1503PTF
Three needles for lap sewing



V-82000C
Two needles belt loop machine
with front fabric cutting

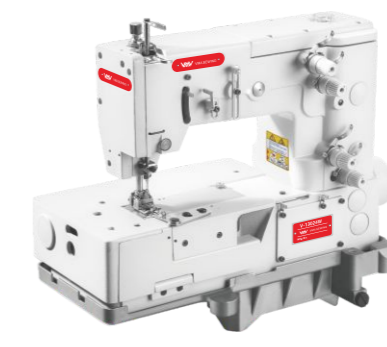

V-13024W
Single/double needles 4 point
ZIG-ZAG machine

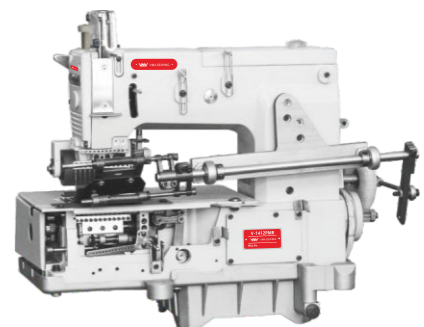

V-1412PMR
Twelve needles for shirt pleating



V-1412PSM
Twelve needles for shirring and smocking



V-1423P
1/8 twenty three needles with
vertical looper movement
3/16 needle gauge distance reach
108.8mm between first and last needle
1/4 needle gauge distance reach
152mm between first and last needle



V-4412ATE
Twelve needles auto trimmer machine

PARAMETER DATA



Model	Needles	Needle NO.	Thread	Needle gauge	Stitch length	Presser foot lifter	Speed	Weight	Measurement
V-008VC-04064P	4	UOx113 14	8	1/3	7-17	8	4000rpm	48/52kg	60x40x60cm
V-008VC-12064P	12	UOx113 14	24	1/8,3/16,1/4	7-17	8	4000rpm	48/52kg	60x40x60cm
V-008VC-13032P	13	UOx113 14	26	1/8-1/4-1/8	7-17	8	4000rpm	48/52kg	60x40x60cm
V-008VC-04064VWL	4	UOx113 14	8	1/4	7-17	8	4000rpm	48/52kg	60x40x60cm
V-008VC-04064VSF	4	UOx113 14	8	1/4-3/4-1/4	7-17	8	4000rpm	48/52kg	60x40x60cm
V-008VC-08064VPL	8	UOx113 14	16	1/4	7-17	8	4000rpm	48/52kg	60x40x60cm
V-008VCD-12064VSQ	12	DVx57 14	24	3/16,1/4	7-17	8	4000rpm	48/52kg	60x40x60cm
V-008VC-12064VPS	12	DVx57 14	24	3/16,1/4	7-17	8	4000rpm	48/52kg	60x40x60cm
V-008VC-12064VPT	12	DVx57 14	24	3/16,1/4	7-17	8	4000rpm	48/52kg	60x40x60cm
V-1404P	4	UOx113 14	8	3/4,1/4,3/16,5/16	7-17	10	4000rpm	44/48kg	60x40x60cm
V-1406P	6	UOx113 14	12	1/3,1/4,3/16,3/8	7-17	10	4000rpm	44/48kg	60x40x60cm
V-1412P	12	UOx113 14	24	1/8,3/16,1/4	7-17	10	4000rpm	53/57kg	60x40x60cm
V-1413P	13	UOx113 14	26	1/4,1/8-1/4-1/8-1/4	7-17	10	4000rpm	53/57kg	60x40x60cm
V-1417P	17	UOx113 14	34	1/8,3/16	7-17	10	4000rpm	53/57kg	60x40x60cm
V-1404PMD	4	UOx113 14	8	1/3,1/4,3/16,5/16	7-17	10	4000rpm	44/48kg	60x40x60cm
V-1404PSF	4	UOx113 14	8	3/16-3/4-3/16,1/4-1-1/4,1/4-3/4-1/4	7-17	10	4000rpm	44/48kg	60x40x60cm
V-1408PL	8	UOx113 14	16	3/16,1/4,5/16,3/8	7-17	10	4000rpm	44/48kg	60x40x60cm
V-1412PQ	12	DVx57 14	36	3/16,1/4	7-17	10	4000rpm	53/57kg	60x40x60cm
V-1412PS	12	DVx57 14	24	3/16,1/4	7-17	10	4000rpm	53/57kg	60x40x60cm
V-1412PTU	12	DVx57 14	24	3/16,1/4	7-17	10	4000rpm	53/57kg	60x40x60cm
V-1508P	4	TVx5 21	8	1/4-1-1/4	7-16	10	4000rpm	45/48kg	60x40x60cm
V-1509P	6	TVx5 21	12	1/8-1/8-1-1/8-1/8	7-16	10	4000rpm	45/48kg	60x40x60cm
V-1503PTF	3	TVx5 21	6	1/4	7-16	10	4000rpm	45/48kg	60x40x60cm
V-82000C	2	UY 128 16	4	3/16,1/4	9-12	8	4000rpm	42/46kg	60x40x60cm
V-13024W	2	UOx163 11	4	-	2-5.5	8	3000rpm	48kg	60x40x60cm
V-1412PMR	12	UOx113 14	24	1/8,3/16,1/4	7-17	10	4000rpm	53/57kg	60x40x60cm
V-1412PSM	12	DVx57 14	36	3/16,1/4	7-17	10	4000rpm	53/57kg	60x40x60cm
V-1423P	23	UOx113 14	46	1/8,3/16	7-17	10	4000rpm	53/57kg	60x40x60cm
V-1412ATE	12	UOx113 14	24	3/16,1/4	7-17	8	4000rpm	48/52kg	60x40x60cm

TOP & BOTTOM FEED LOCKSTITCH



V-0303D

Direct drive top & bottom feed lockstitch



V-0303

Mechanical top & bottom feed lockstitch



V-0303ED-4

Electronic top & bottom feed lockstitch

V-0303CX

Direct drive top & bottom feed lockstitch
12mm stitch length



V-0303E-33

Electronic top & bottom feed lockstitch
33cm longer operation space



V-0352E

Electronic top & bottom feed lockstitch
with edge cutter



V-0352

Mechanical top & bottom feed lockstitch
with edge cutter



V-0360E

Electronic long arm top & bottom
feed lockstitch



V-0385E

Electronic long arm top & bottom feed lockstitch,
85cm operate length

Model	Needle	Thread	Stitch length	Presser foot height	Speed	Weight	Measurement
V-0303	DPx17 18-24#	2	0-8mm	6-13mm	2000rpm	25.5/32.5kg	58x25x53cm
V-0303DCX	DPx17 18-24#	2	0-12mm	6-13mm	1800rpm	25.5/32.5kg	58x25x53cm
V-0303E	DPx17 18-24#	2	0-8mm	8-16mm	2500rpm	42/48kg	63x22.5x55cm

POST BED MACHINE BEARING CONSTRUCTION



V-69910E
Electronic post bed machine



V-69920E
Electronic post bed machine



V-69910S
Double step motor control, use touch screen



V-69920S
Double step motor control, use touch screen

Model	Needle	Thread	Stitch length	Presser foot height	Speed	Weight	Measurement
V-69910E	DPx5 11-22#	2	0-7mm	15mm	3000rpm	54/58kg	67x33.5x68cm

POST BED MACHINE BEARING CONSTRUCTION



V-69910D
Direct drive post bed machine single needle compound feed



V-69920D
Direct drive post bed machine single needle compound feed



V-69910
Mechanical post bed machine single needle compound feed



V-69920
Post bed machine double needle



V-69910E-K
Electronic post bed machine with edge cutter



V-1760

Model	Needle	Thread	Stitch length	Presser foot height	Speed	Weight	Measurement
V-69910	Dpx5 17-23 #	2	0-7	7mm	2500rpm	54/58kg	62.5x32x64cm
V-69920	DPx5 17-23 #	2	0-5.5	7mm	2500rpm	54/58kg	62.5x32x64cm
V-1760	DPx17 19-23#	4	0-9mm	16mm	2000rpm	54/58kg	67X33.5X68cm

POST BED MACHINE



V-68810

Post bed machine single needle round body



V-68820

Post bed machine double needle round body



V-68910/68920

Post bed machine single-double needle square body



V-68810DQ

Cap belt sewing attaching and cutting with pneumatic belt cutter



V-68811W

Design for wig sewing



V-68810D

Post bed auto-lubrication direct drive design, with auto bobbin winder, with needle position

Model	Needle	Thread	Stitch length	Presser foot height	Speed	Weight	Measurement
V-68810	DPx5 19-22#	2	7mm	6mm	3000rpm	35/39kg	64x27x57.5cm
V-68820	DPx5 19-22#	4	7mm	6mm	3000rpm	35/39kg	64x27x57.5cm

POST BED MACHINE



V-857E-4

Auto trimmer needle feed post bed machine, single needle, 178mm height sewing bed, normal presser foot, auto presser foot lifter



V-867E-4

Auto trimmer needle feed post bed machine, double needle, 178mm height sewing bed, auto presser foot.



V-682440/V-682442

Post bed machine for bags



V-683442

Post bed machine for shoes, 43cm height



V-69910R

Arm movable post bed sewing machine with pneumatic auto presser foot lifter



V-68365

Super high post bed machine compound feed



V-68760-60

Super high post bed machine square sewing bed machine



V-68760-70

Super high post bed machine square sewing bed 3 times big hook with 73cm height and 46cm height or other height as required

Model	Needle	Thread	Stitch length	Presser foot height	Speed	Weight	Measurement
V-6857D	DPx5 19-22#	2	5mm	10mm	2500rpm	35/39kg	64x27x57.5cm
V-6867D	DPx5 19-22#	4	5mm	10mm	2500rpm	35/39kg	64x27x57.5cm
V-68365	DPx17 17-23#	2	3-9mm	8-15mm	1600rpm	55/60kg	68x39x91cm

CYLINDER BED COMPOUND FEED LOCKSTITCH



V-2628

Cylinder bed compound feed lockstitch auto lubrication horizontal hook for cover



V-2628-2

Cylinder bed compound feed lockstitch auto lubrication oval-shaped hook for lockstitch



V-8B

Cylinder bed compound feed lockstitch standard hook



V-246

Cylinder bed(smaller) compound feed lockstitch auto lubrication horizontal hook for lockstitch or over of bag or luggage



V-246A

Cylinder bed compound feed lockstitch auto lubrication horizontal hook auto lubrication for lockstitch or over of bag or luggage



V-246AL

Long arm cylinder bed compound feed lockstitch auto lubrication horizontal hook



V-335A

Cylinder bed compound feed for shoes binding

V-335B
is big hook



V-341D

Cylinder bed compound feed lockstitch with reverse feed more heavy



V-341A

Cylinder bed compound feed lockstitch with reverse feed auto lubrication



V-341AL

Long arm cylinder bed compound feed lockstitch with reverse feed auto lubrication stitch length 11mm extra heavy thread 20 lines



V-342

Cylinder bed compound feed double needle for car seats



V-1341-7

Cylinder bed compound feed with auto trimmer and pneumatic presser foot lifter

COMPOUND FEED LOCKSTITCH



V-5942C-1 / V-5942C-2

Compound feed lockstitch, single / double needle 4400/4420 type



V-1510D/V-1560D

Direct drive compound feed lockstitch horizontal hook single/double needle,with switch for adjust presser foot height



V-1565N

Compound feed lockstitch horizontal hook double needle splitter needle bar



V-5942D-1 / V-5942D-2

Direct drive compound feed lockstitch, single/double needle



V-1510E/V-1560E

Electronic compound feed lockstitch horizontal hook single/double needle,with switch for adjust presser foot height



V-6668

Compound feed lockstitch vertical hook

Model	Needle	Thread	Stitch length	Presser foot height	Speed	Weight	Measurement
V-62681	Dpx17 18-24#	2	0-5mm	6-15mm	2000rpm	41/44kg	58x25x53cm
V-341	DPx17 18-24#	2	0-9mm	6-15mm	2000rpm	41/44kg	61x28x58cm
V-246	DPx17 18-24#	2	0-8mm	6-15mm	2000rpm	41/44kg	57.5x27.5x62cm

Model	Needle	Thread	Stitch length	Presser foot height	Speed	Weight	Measurement
V-1510D	DPx17 19-23#	2	3-9mm	8-16mm	2500rpm	40.5/47.5kg	67x35x36.5cm
V-5942C-1	DPx17 8-23#	2	3-9mm	8-16mm	2000rpm	40.5/47.5kg	67x35x36.5cm
V-6668	DPx17 22-24#	2	0-10mm	8-14mm	2000rpm	25.5/32.5kg	58x25x53cm

SPECIAL HEAVY DUTY MACHINE



V-1510N-AE
Compound feed auto cutting and binding lockstitch



V-SH8810
Lockstitch with roller presser foot

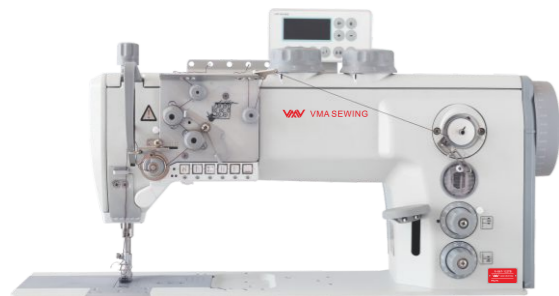

V-867-122TB
Compound feed lockstitch, single needle, with auto trimmer, presser foot lifter height amount auto adjust during sewing, stitch length auto adjustable during sewing

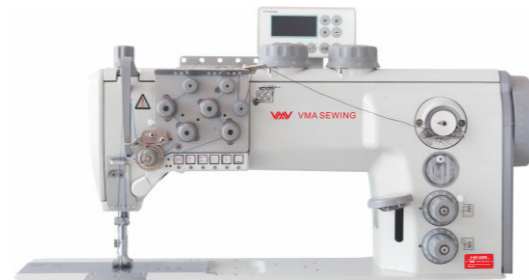

V-867-222TB
Compound feed lockstitch, double needle, with auto trimmer, 9mm stitch length, normal heavy thread(not super heavy thread), 32mm big bobbin, presser foot lifter height amount auto adjust during sewing, stitch length auto adjustable during sewing



V-243-1-17
Lockstitch for extremely heavy duty materials, triple feed, big shuttle hook



V-05781
Feed off the arm extra heavy duty machine

Model	Needle	Thread	Stitch length	Presser foot height	Speed	Weight	Measurement
V-1510N-AE	DPx17 19-23#	2	3-9mm	8-16mm	2000rpm	40.5/47.5kg	67x35x36.5cm
V-05781	DPx17 19-23#	2	0.6-1.0mm	8-16mm	2000rpm	240	131x78x144

LONG ARM COMPOUND FEED LOCKSTITCH



V-60698P-1/V-60698P-2
Long arm machine (single / double needle) with servo motor & pneumatic presser foot lifter & back sewing function



V-1510-L25 / V-1560-L25
Direct drive long arm machine (single / double needle), presser foot lift amount adjustable during sewing

Model	Needle	Thread	Stitch length	Presser foot height	Speed	Weight	Measurement
V-60698P-1	DPx17 18-23#	2	3-9mm	8-16mm	1800rpm	70/80kg	129x57x33cm

HEAVY DUTY PATTERN SEWING MACHINE



V-266L-102N

Newest stitch designs heavy duty pattern sewing machine



V-366-102D

Post bed single & double needle top & bottom feed heavy duty pattern sewing machine

EXTRA HEAVY DUTY MACHINE



V-204

Largest rotary hook working foot, furniture heavy duty machine



V-205

Cylinder bed top & bottom feed extra heavy duty machine



V-266-102D

Single & double needle top & bottom feed heavy duty pattern sewing machine



V-82-A

Double needle shoes face edge sewing machine

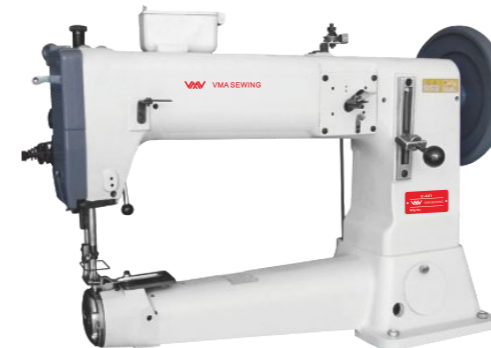

V-441

Cylinder bed compound feed lockstitch extra heavy duty , with special large rotary hook



V-366-76x12HAP

Long arm extra heavy duty zigzag machine with options of high space and puller

Model	Max speed	Stitch length	Thread take-up lever stroke	Needle bar stroke	presser foot	Diameter of cylinder	Rotating hook	Needle size	Lubrication	Motor	Height
V-441	800r.p.m	0-11 mm	96mm	56mm	By hand: 13mm By knee: 20mm	81 mm	KSP-204N	DYx327#	Manual oiling	550W 4P	78mm
V-205	800r.p.m	0-11 mm	96mm	56mm	By hand: 13mm By knee: 25mm	81 mm	KSP-204N	DYx327#	Manual oiling	550W 4P	78mm

Model	Needle	Thread	Stitch length	Presser foot height	Speed	Weight	Measurement
V-336-76x12HAP	DPx3 25#	2	12mm	20mm	800rpm	120/140kg	140x60x50cm

SHOES MACHINE



V-T801

Round knife peeling machine

Model	Speed	Weight	Measurement
V-T801	1200rpm	40/44kg	63.5x42.5x42cm



V-168

Double thread lockstitch seated type shoe-border stitcher
Size S M L are available, from kids shoes to snow boots.

Model	Stitch length	Sewing thickness	Sewing needle	Weight	Overall size	Shuttle hook diameter/ thickness
V-168	3-13mm	1.5-6mm	CPx5	150kg	107x56x125cm	26/11mm



V-2792

Shoes repair machine

Product Overview:

- Can attach clutch motor, max speed 500RPM.
- Presser foot lifter 15mm; needle DPx17 Dlx3, max. stitch length 10mm.
- Can 360 degree turn on the shoes during sewing, small cylinder bed, with the width no more than 28mm.
- Can sewing the small and special materials which with small angle.

VMA SEWING



V-T801S

Round knife peeling machine original korea design fully enclosed



V-255

Seam opening and tape attaching machine

Convenient to use, easy to operate and good for shaping. Upper wheel teamed lower wheel feed materials that can increase cohesion between leathers or clothes, high foundation with wide application scope. It is suitable for gluing and shape modifying of all kinds of heel pieces.



V-2791

Manual work shoes repair machine

SHOES INNERSIDE TRIMMING MACHINE

VMA SEWING

V-207

Outsole digging trimmer is specialized in the repair process cut uppers and rubber soles, no pattern of holes aside, burr groove shape within 5mm small hole, ditch are very clean and repair will not hurt the upper sole body.

Allows you to use it quickly and easily, improve efficiency. Reduce cost of production.

It is a good partner during the trimming work.



V-202Z

Innerside trimming machine motor build in head



V-902

Innerside trimming machine



V-206

Innerside trimming machine



V-203

Innerside trimming machine for lady shoes



V-111A

Suitcase trimming machine with double movable round knife

Model	Sewing speed	Delivery speed	Cut thick ability	Orbit hoisting height
V-111A	2000rpm	50-65cm/s	25-30mm	10-15mm

FUR SEWING MACHINE & UPPER DRAWING MACHINE



V-4-4
Fur machine thin material



V-4-5
Fur machine medium material



V-4-5A
Fur machine for gloves



V-4-4D
Direct drive fur machine thin material



V-4-5D
Direct drive fur machine medium material



V-4-5AD
Direct drive fur machine for gloves



V-4-6
Fur machine heavy duty



V-4-6A
Fur machine insole edge cover machine extra heavy, bigger stitch length, small press plate, double thread



V-2610-5BD
Direct drive fur machine for join with leather material



V-2610-2D
Direct drive fur machine double thread stitch



V-2610SD
Direct drive fur machine binding the cord



V-2610F-SM
Direct drive fur machine double face woolled coat

Model	Needle	Thread	Stitch length	Needle gauge	Presser foot height	Speed	Weight	Measurement
V-4-4	E8*1567 45#	1	0.7-2.5	2.5	22	3200rpm	20/23kg	40.5x35.5x35cm
V-4-5	DBx1 11#-14#	1	0.9-3	2.5	25.5	2800rpm	19.5/23kg	40.5x35.5x35cm
V-4-5A	DBx5 11#-16#	1	1.5-5	3	29	2800rpm	19.5/23.5kg	40.5x35.5x35cm
V-4-4D	EB*1567 45#	1	0.7-2.5	3	22	0-3200rpm	24.5/28kg	42x41x34.5cm
V-4-5D	DBx1 11#-14#	1	0.9-3	2.5	25.5	0-2800rpm	24.5/28kg	42x41x34.5cm
V-4-5AD	DBx1 11#-16#	1	1.5-5	3	29	0-2800rpm	24.5/28kg	42x41x34.5cm
V-4-6	DBx1 14#-16#	1	1.5-5	2	29	2500rpm	20.6/24kg	40.5x35.5x35cm
V-4-6A	DBx5 19#-22#	1	2-10	3	29	2500rpm	20.6/24kg	40.5x35.5x35cm
V-2610-5BD	DBx1 16x231 65/9	1	2-5	3-6	22	2500-3000rpm	24.5/28kg	42x41x34.5cm
V-2610-2D	DBx1 96x1 11/75	2	1-7	3-6	22	0-2300rpm	24.5/28kg	42x41x34.5cm
V-2610SD	DB*1NY 16/231 SES 7/55	1	3-5	3	22	2500-3000rpm	24.5/28kg	42x41x34.5cm
V-2610F-SM	DB*1NY 168231 SES 7/55	1	3-5	3	22	2500-3000rpm	24.5/28kg	42x41x34.5cm

UPPER DRAWING MACHINE



V-T600
Heavy duty lubrication over-seaming machine for extremely thick leather, sports shoes, insole of the California shoes, working gloves, boots and baby's shoes



V-T6003D
Direct drive heavy duty lubrication over-seaming machine increase 7-10mm sewing thickness



V-T6003P/UT
Pneumatic trimmer and presser foot lifter heavy duty lubrication over-seaming machine



V-T202D
Direct drive upper drawing machine for baby shoes



V-T202
Upper drawing machine 3.5mm thickness for gloves, sports shoes, clothes and hats, etc.



V-T302
Upper drawing machine 4.5mm thickness for toys, gloves, car seat cushion and head phone covers etc.



V-T402
Upper drawing machine 5.5mm thickness for upper and sole of snow boots, sports shoes, children shoes etc.



V-T402A
Upper drawing machine 5.5mm thickness with big presser disc plate for toys, gloves, car cushions etc.



V-GP800-1
Heavy duty lubrication over-seaming machine single needle single thread for insole of shoe(sports shoes or California style shoes)



V-GP800-2
Heavy duty lubrication over-seaming machine single needle double thread widely use, such as diving suits, leather, fur, sheep skin and double face combination of fur and fabric, edging collars, sleeves and foreparts, with 2 thread chain stitch.

Model	Needle	Thread	Stitch length	Needle gauge	Presser foot height	Speed	Weight	Measurement
V-T600	DBx5 19# / 22#	1	6	5	33	2800rpm	30-34.5kg	50.5x41x37.5cm
V-T6003D	DBx5 20 / 125#	1	3-7	7	33	0-2000rpm	35-40kg	50.5x43x37.5cm
V-T6003P/UT	DBx5 20 / 125#	1	3-7	7	33	0-2000rpm	36/41kg	50.5x43x37.5cm
V-T202D	DBx1 16x231 65/9	1	1-3.5	3.5	25	0-2300rpm	23/26kg	43x31x37cm
V-T202	DBx5 11#-14#	1	1-3.5	3.5	25	2300rpm	17.5/21kg	43x31x37cm
V-T302	DBx5 14#-19#	1	1.5-5	4.5	29	2300rpm	17.7/21kg	43x31x37cm
V-T402	DBx5 18#-22#	1	1.5-5	5	32	2000rpm	19/22kg	43x31x37cm
V-T402A	DBx5 18#-22#	1	1.5-5	5	32	2000rpm	19/22kg	43x31x37cm
V-GP800-1	DBx35LR 23#	1	3-8	5.5-6	32.4	2800rpm	23/26.5kg	50.5x43x37.5cm
V-GP800-2	DBx5 14#-22#	2	3-8	4.5-6	28	2800rpm	23/26.5kg	50.5x43x37.5cm

SHOES MACHINE



SHOES HEEL LINING SEPARATING SIDES POUNDING MACHINE



V-298-B

Computerized hot -cement shoes edge fold machine with single chip to control gelatinize, auto control the cutting when turn the material, auto slow the speed of folding outer bending edges, control by 3 photosensitive points. Working speed adjustable, size of bending could chose, folded edge 3-9mm , temperature of hot melt change by system, glue amount also adjustable by parameters, 5-10 times more efficiency



V-298-C

Computerized hot -cement shoes edge fold machine during inner turning can automatic adjust the width



V-525

Shoes insole (middle bottom) edge tape attach and covering machine



V-296

For 2 pieces material gap more than 3mm



V-296F

For 2 pieces material gap between 1.2-2.0mm



V-296F1

For 2 piece material gap between 1.2-2.0mm, with tape feeding & auto cutting tape function



V-296-A

Movable sewing arm for luggage and bags etc.



V-296-B

For all kinds of high boots



V-296C

For special tape which already come with glue



V-928-F

Automatic cementing zipper covering machine (gear cutting over pull head) Suitable for many kinds of zipper such as notebook, wallet, fashion bag, cosmetic bag, wallet, single double bags and other leather products, which size 3#, 5#, 7#, 8#. Automatic feeding, gluing, positioning, induction, slow speed, improve 6-8 times efficiency



V-FX821

Automatic cover-type sole attaching machine gluing machine Air control the open/close the cover, with sensor protection overload. Pressing time 2-99S, 0.2-0.7Mpa. 170 pairs / hour, 160/180kg, 750x400x1200mm



V-618L

Gluing machine 280mm range, 15m/min, 0.25kw, 460*238x255mm 32/35kg

Model	Voltage	Power	Weight	Measurement
V-298-C	220V	0.65kW	135kg	120x55x125mm
V-928-F	220V	0.75kW	108kg	121x55x116mm

Model	Voltage	Power	Weight	Measurement
V-296F1	220V 50-60Hz	0.75kW	113kg	125x55x120cm
V-296	220V 50-60Hz	0.65kW	113kg	125x55x120mm

CUTTING CLOTH AND LEATHER STRIP MACHINES



V-T801A
Cutting cloth strip machine



V-T802A
Cutting cloth strip machine double knife

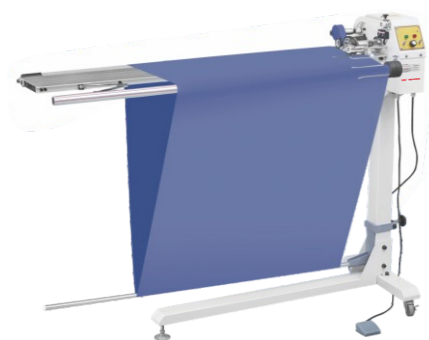

V-T911
Bigger cutting cloth strip machine



V-T933
Bigger cutting cloth strip machine for elastic cloth



V-T803AT
Full automatic cutting cloth strip machine, 3-5 knives



V-512-2
Cutting leather strip cutting width 16" inch 400mm, speed 10m/min, adjustable strip width, knife 80x40x1mm, 380/220V, 135/150kg. Also cutting width have 14 inch 345mm and 20 inch 508mm.



V-T531
Horse leather cutting machine Italy powerful design Cutting width adjustable, knife speed 90rpm, feeding speed 20m/min, power 550W, 380/220V, 196/210kg, 840x450x1260mm

Model	Knife	Pulley height	Speed	Voltage	Weight	Measurement
V-T801A	1	16-51	1400rpm	110V/220V	20.5/23.5kg	82x34x25cm
V-T802A	2	16-51	1400rpm	110V/220V	20.5/23.5kg	82x34x25cm

COMPUTERIZED FULLY-AUTOMATIC STRIP CUTTING MACHINE



V-SL2011A
Computerized fully-automatic strip cutter with dust suction

Microcomputer programmed data input, visual interface for operation and easy&comfortable start-up.
Programmable data control, step motor drive, accurate size for the needs, five different sizes of cutting on the same cloth beam; once the machine is started, it can complete cutting once in a time.
Magic eye for the monitoring, manual or automatic knife sharpener; the time for pause can be set and the sharpeners can work simultaneously.
Chinese&English operation interface, which is suitable for many languages; it is simple and understandable for ordinary workers.
Vacuum unit to remove excess trimmed material and sharpening dust.



V-SL2000A
Computerized fully-automatic strip cutter without dust suction



V-SL2000
Mechanical strip cutter

Model	Band width	Maximum operation width	Output each workday	Maximum roll diameter	Blade diameter	Power	Machine dimension (LxWxH)
V-SL2011A	5-1680MM	2200MM	2000M-6000M (10MM-35MM)	Φ280mm	Φ400mm	220V/380V	2800x1250x1400mm

BAND KNIFE CUTTING MACHINE



V-BK700
Band knife cutting machine



V-BK900
Band knife cutting machine



V-BK1200
Band knife cutting machine

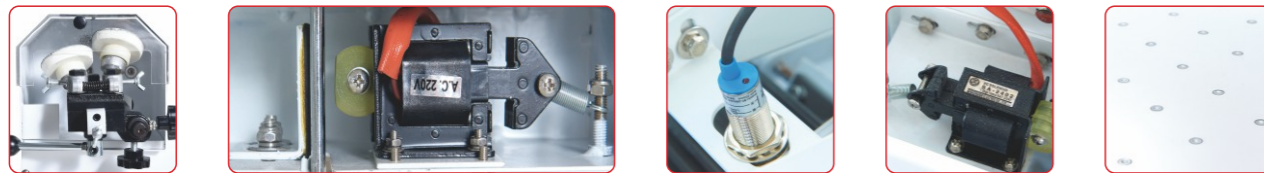

Band knife cutting series suitable for various fabric, woven / knitting / synthetic fiber(nylon, vinylon, acrylic) / sponge / synthetic leather/ felt, etc.

Product Overview:

- Speed 3 level adjustable, for different material;
- Easy to change the cutting knife;
- With safety protection device.
- Air-floated blowing table with small balls, easy to move;
- With knife grinding device;

Model	Cutting height	Bonding pressure	Cutting motor power	Linear velocity of tool	Weight	Measurement
V-BK700	180mm	12kpa	750w	11.0; 12.2; 13.3m/min	247kg	153x76x175cm
V-BK900	180mm	12kpa	750w	11.0; 12.2; 13.3m/min	276kg	188x76x175cm
V-BK1200	200mm	15kpa	750w	11.0; 12.2; 13.3m/min	338kg	250x76x175cm

END CUTTER MACHINE



V-T1
Manual end cutter

V-T1-2
Manual end cutter with double press bar



V-TDB2
Semi-automatic end cutter



V-TDB3
Full-automatic end cutter

Model	Cutting thickness	Max. cutting width	Rail length	Speed	Power	Weight	Measurement
V-T1	9mm	1.2-3mm	1.6m-3.6m	1200rpm	160W	"head 15/18kg rail 3/3.5kg"	"head 76.5x46x19.5cm rail 280x13x3cm"
V-T1C	25mm	1.2-3mm	1.6m-3.6m	1300rpm	245W	"head 15/18kg rail 3/3.5kg"	"head 76.5x46x19.5cm rail 280x13x3cm"
V-T1H	50mm	1.2-3mm	1.6m-3.6m	1500rpm	250W	"head 15/18kg rail 3/3.5kg"	"head 76.5x46x19.5cm rail 280x13x3cm"
V-TDB2	9mm	1.2-3mm	1.6m-3.6m	1200rpm	200W	"head 15/18kg control 28/33kg rail 3/3.5kg"	"head 96x49x32.5cm control 76x43x32.5cm rail 280x13x3cm"
V-TDB3	9mm	1.2-3mm	1.6m-3.6m	1200rpm	200W	"head 15/18kg control 28/33kg rail 3/3.5kg"	"head 96x49x32.5cm control 76x43x32.5cm rail 280x13x3cm"

STRAIGHT KNIFE CUTTING MACHINE



THREAD CLEANING MACHINE



V-T103DK-10"
Servo motor



V-T103DK-10"-NB
Servo motor



V-T103DK-10"-BL
Servo motor



V-T3-10"/750W-BK
Eastman model



V-T3-10"/850W



V-T3J-10"/850W



V-T103-10"/550W
KM model



V-T3L
With LED light



V-T108-5"/370W
Five inch



V-T102H
Drilling hole machine with heating device



V-T3-17"
With 17" inch, can choose 750W/850W/1200W



V-T3CH-28"
750W Cutting cotton, also have 18" inch or 24" inch



V-TC0-T
Brushless smart oiling thread trimming machine, with screen



V-TC2-2B
Double head double brush motor



V-TC1-1STA
With table style, single head one brushless, with sensor for auto working, time adjustable.



V-TC2-2SH
Double head double brushless(servo) motor high class



V-GT26-3BL
Hand-held for pans



V-S1/V-S2
Electronic suction bottle for overlock/ electronic suction bottle for interlock

Model	Cutting thickness	Speed	Power	Voltage	Frequency	Weight	Measurement
V-T3	110 160 210 260	2800/3450rpm	550/750W	110/220V	50/60Hz	15/18kg	72x39x30cm
V-T103DK	110 160 210 260 285	1000-4000rpm	1600W	220V	50/60Hz	17/20kg	72x39x30cm
V-T108	190	2800-3400rpm	370W	110/220V	50/60Hz	9.5/11.5kg	53x32x23cm
V-T102H	>=100	3000rpm	250W	220V	50/60Hz	5.5/6kg	58.5x29x25cm

SMALL ROUND KNIFE CUTTING MACHINE



V-N100B-RE

Brushless round knife cutting machine use battery drive, wireless type, size 100mm



V-N110B-BL

Brushless round knife cutting machine use battery drive, wireless type, size 110mm



V-N125B-NB

Brushless round knife cutting machine use battery drive, wireless type, size 125mm



V-N100D-RE

Brushless round knife cutting machine size 100mm



V-N110D-BL

Brushless round knife cutting machine size 110mm



V-N125D-NB

Brushless round knife cutting machine size 125mm

Brushless round knife cutting machine

- Two 2900mA high-capacity battery;
- Each battery intermittent work about 4~8 hours;

- Charging takes 2.5 hours;
- Electric car level quality control.

- Wide voltage 100~240V

Advantage

Battery improved from 2500mA to 2900mA



Battery improved to be 2900mA



Speed adjustable 800~1600rpm



Light weight and low noise

NO NEED

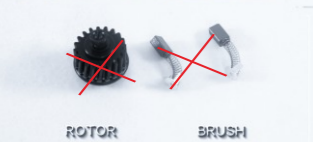

No need brush



Tool box package

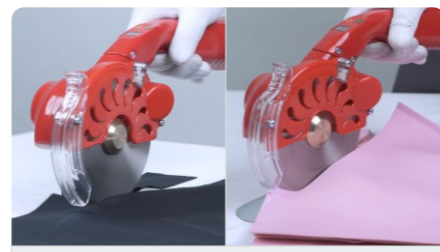

Diversified cutting

Model	Cutting thickness	Blade diameter	Speed	Voltage	Weight	Measurement
V-N125B	40	125(4.92 inch)	1600	100-240V	5pcs 15/16.2	67.5x35.5x27.5cm
V-N110B	32	110mm (4.33 inch)	1600	100-240V	5pcs 15/16.2	67.5x35.5x27.5cm
V-N100B	27	100mm (4 inch)	1600	100-240V	5pcs 15/16.2	67.5x35.5x27.5cm

SMALL ROUND KNIFE CUTTING MACHINE



V-T100D-RE



V-T110B-OR



V-T125B-BL



V-T125

Small round knife



V-T110

Small round knife



V-T100

Small round knife



V-T90

Small round knife



V-T70

Small round knife



V-T65

Small round knife



V-T50

Small round knife



V-HK8901

Hot cutting knife with presser foot



V-Z400

Sample fabric cutting machine, with tooth edge

Model	Cutting thickness	Blade diameter	Speed	Power	Voltage	Weight	Measurement
V-T125	40	125(4.92 inch)	560	350W	110/220/240V	4pcs 16/19kg	65x38x39cm
V-T110	32	110mm (4.33 inch)	800	250W	110/220/240V	5pcs 17/19kg	57x37x46.5cm
V-T100	27	100mm (4 inch)	800	250W	110/220/240V	5pcs 17/19kg	57x37x46.5cm
V-T90	25	90mm(3+1/2 inch)	1000	200W	110/220/240V	5pcs 11/14kg	72.5x32x30cm
V-T70	24	70mm (2+3/4 inch)	2600	170W	110/220/240V	10pcs 12/15kg	35x32x53cm
V-T65	22	65mm(2.56 inch)	2400	150W	110/220/240V	15pcs 18/21kg	62x32x26cm
V-T50	10	50mm(2 inch)	1800	60W	110/220/240V	10pcs 10/13kg	32x26x39.5cm

BELT LOOP CUTTER SERIES

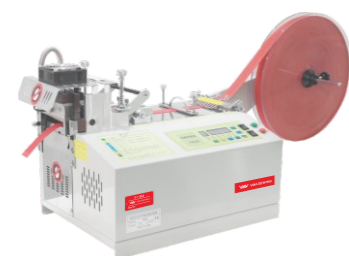

V-110LR
Basic belt loop cutter cold & hot knife



V-110H
Basic belt loop cutter hot knife



V-110L
Basic belt loop cutter cold knife



V-110R
Basic belt loop cutter round design



V-110HLR
Label cutter cold/hot knife, with sensor for recognize the label line

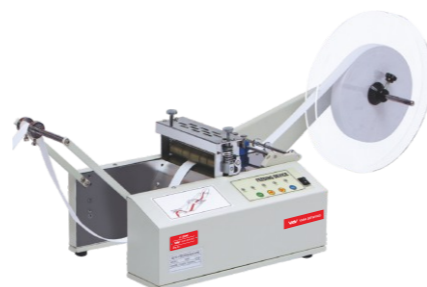

V-300M
Tape feeding device



V-120LR
Belt loop cutter cold & hot knife



V-120LRQ
Pneumatic belt loop cutter cold & hot knife



V-120R
Velcro tape round shape cutter

BELT LOOP CUTTER SERIES



V-120HX
Belt loop cutter hot knife, for bevel angle cutting and straight angle cutting



V-120HLR
Label cutter cold/hot knife, with sensor for recognize the label line



V-130LR
Heavy duty cold & hot cutter



V-150HX
Multi-function auto cutting machine, for bevel angle cutting and straight angle cutting



V-2286A-R-CCD

Ultrasonic auto elastic cutting machine

With rotary cutter for 2 side different angle cutting, with visual system detect logo, ultrasonic welding and cutting products perfect, special pin wheel design make sure elastic band with accurate transport.

Each machine, size 500mm (19 5/8") could produce 30pcs per minute, and one worker could operate 2~3 machine.



Model	Cutting length	Max.cutting width	Cutting speed	Max. blade temp	Voltage	Frequency	Weight	Measurement
V-110H	20-9999	100	120	420°C	110/220	50/60	24/29kg	56x42x40.5cm
V-120R	20-99999	10-50	90	300°C	110/220	50/60	24/29kg	56x42x40.5cm

Model	Cutting length	Max.cutting width	Cutting speed	Max. blade temp	Voltage	Frequency	Weight	Measurement
V-120HX	20-99999	35/55	100	350°C	110/220	50/60	24/29kg	56x42x40.5cm
V-120HLR	20-99999	95	90	300°C	110/220	50/60	24/29kg	56x42x40.5cm
V-130LR	20-99999	190	80/100	300°C	110/220	50/60	17kg	55x44.5x47.5cm

LASER CUTTING MACHINE



V-LS140100-1

Laser cutting machine, single head, working area 140x100cm

Model	V-LS6040/V-LS9060/V-LS10080/V-LS12080/V-LS140100/V-LS160100
Laser Type:	Sealed Co2 glass laser tube 60W /80W / 100W / 130W
Cutting Area:	600x400 / 900x600 / 1000x800 / 1200x800 / 1400x1000mm/1600x1000mm
Engraving Speed:	1- 60000mm/min
Resetting positioning accuracy:	±0.01mm
Cooling Mode:	Water Cooling
Supported File:	PLT、 AI、 DXF、 DST、 BMP、 JPGE (etc)
Compatible Software:	CorelDraw, AutoCAD, Photoshop
Power	AC 220V+10%, 50 / 60Hz
Working Environment	Temperature:0- 30°C; Humidity:30- 80%(No condensate water)



V-LS160100-2-F90W

Laser cutting machine, single head, working area 160x100cm

Model	V-LS12080/V-LS140100/V-LS160100/V-LS180100
Laser Type:	Sealed Co2 glass laser tube 60W /80W / 100W / 130W / 150W
Cutting Area:	1200x800 / 1400x1000 / 1600x1000 / 1800x1000mm
Engraving Speed:	1- 60000mm/min
Resetting positioning accuracy:	±0.01mm
Cooling Mode:	Water Cooling
Supported File:	PLT、 AI、 DXF、 DST、 BMP、 JPGE (etc)
Compatible Software:	CorelDraw, AutoCAD, Photoshop
Power	AC 220V+10%, 50 / 60Hz
Working Environment	Temperature:0- 30°C; Humidity:30- 80%(No condensate water)
Certification:	CE

LASER CUTTING MACHINE



V-LS1610AF

Auto feeding laser cutting machine 160x100cm

Model	V-LS1610AF
Laser Type:	Sealed Co2 glass laser tube 100W , 130W/150W
Cutting Area:	1600mmx1000mm
Engraving Speed:	1-60000mm/min
Resetting positioning accuracy:	±0.01mm
Cooling Mode:	Auto-Feeding Material System (Convery Table)
Supported File:	Water Cooling
Compatible Software:	PLT、 AI、 DXF、 DST、 BMP、 JPGE (etc)
Power	CorelDraw, AutoCAD, Photoshop
Working Environment	AC 220V+10%, 50 , 60Hz
Certification:	CE

Different sizes of cutting area can be made accordingly.



V-LS180100TC-2

Asynchronous laser cutting machine with top camera, double rail way double head, working area 180x100cm

Model	V-LS180100TC-2
Laser Type:	Sealed Co2 glass laser tube 100W / 130W/150W
Cutting Area:	1800mmx1000mm
Engraving Speed:	1- 60000mm/min
Resetting positioning accuracy:	±0.01mm
Cooling Mode:	Auto-Feeding Material System (Convery Table)
Supported File:	Water Cooling
Compatible Software:	PLT、 AI、 DXF、 DST、 BMP、 JPGE (etc)
Power	CorelDraw, AutoCAD, Photoshop
Working Environment	AC 220V+10%, 50 / 60Hz
Certification:	CE

Different sizes of cutting area can be made accordingly.

V-ATC2520-S7

Product Overview:

The one-piece frame structure of high-quality steel is adopted, and a large-scale machining center is used. All installation datum surfaces are clamped and processed at one time to ensure that all installation points are accurate and stable, and are not easily deformed. There is no need for splicing and secondary adjustment during installation and use, and it can run after power on. Significantly improve installation time, reduce debugging work, and provide more stable running performance. The complete one-piece structure fundamentally solves the vibration offset caused by the high-speed movement of the cutting head, making the cutting more stable and ensuring the precision of cutting

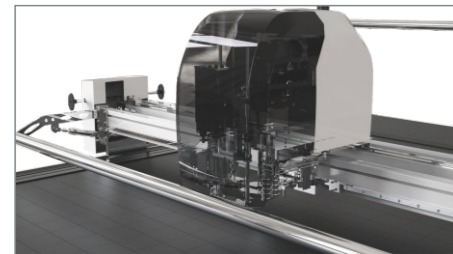

Reciprocating cut

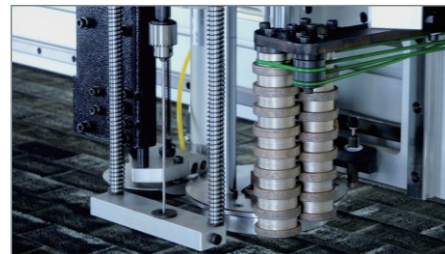

Smart sharpening system

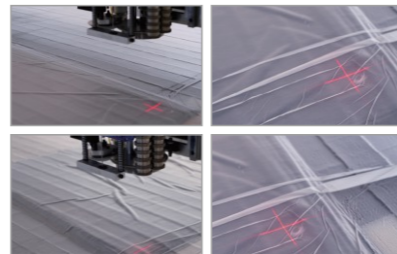

Smart sharpening system



For every 1mm enlargement of the gap between the clothing production markers, 2% of the fabric is wasted.



The waste embedded in the bristlebrick and the drilling waste are cleaned in real time during machine working, which reduces the difficulty of cleaning, prolongs the service life.

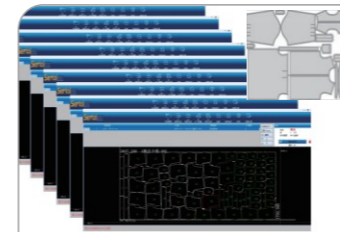

It can be continuously updated and upgraded during use. It is fully compatible with various CAD formats on the market, such as CUT, PLT, DXF, GGT, ISO, GBR, etc



It has advanced functions such as cutting while walking, intelligent deviation correction, constant pressure, etc. It supports CUT, PLT, DXF and other cutting files, and can easily match various clothing CAD. The software is stable and reliable, powerful and flexible in operation. It can be customized and developed to interface with MES and ERP systems, and can be customized to support the Internet of Things. The high-end bus motion controller JuShaMotion is developed based on the Kithara real-time system. It uses Ethercat bus communication to independently develop motion control algorithms such as interpolation, electronic gear, speed look-ahead, and tangential follow-up, and customize a variety of cutting algorithms for computer cutting machines.

Product Series S7	model								
Product number	V-ATC2520-S7			V-ATC2523-S7			V-ATC2017-S7		
Effective cutting range	3.3×1.7M	3.3×2M	3.3×2.3M	2.5×1.7M	2.5×2M	2.5×2.3M	2×1.7M	2×2M	2×2.3M
long	6.8M			6.0M			5.3M		
total weight of equipment	3.6T	3.8T	4T	3.3T	3.5T	3.7T	3.1T	3.3T	3.5T
width	3.3×1.7M	3.3×2M	3.3×2.3M	2.5×1.7M	2.5×2M	2.5×2.3M	2×1.7M	2×2M	2×2.3M
high	1978mm/1988mm								
table height	800mm-850mm								
Effective cutting height (after vacuum adsorption)	70mm/110mm								
power supply	380V/50Hz								
Total installed capacity	25KW								
Average power consumption	12KW								
Air source (dry and clean compressed air)	0.5-0.6MPa 160L/min								
Maximum speed	80m/min								
Average cutting speed	12m/min								
Maximum acceleration	2.5m/s ²								
Maximum vibration frequency	6000r/min								
Knife Specifications	SKH9 S7: 160x8x3/2.5/2 S11: 200x8x3/2.5/2								
Operating system	WINDOWS								
CAD compatible	CUT、PLT、DXF、GGT、ISO、GBR								
Maximum vacuum negative pressure	18-22kpa								

SINGLE LAYER AUTO CUTTING MACHINE



Vibration knife assembly



Round knife assembly

V-PC2518

Product Description:

The single-layer cutting machine offers the best choice for multi-industry proofing and small-volume custom production. Shaped knives and tools to meet all kinds of different materials, intelligent high-speed, high-precision cutting, punching, drawing waiting for work. The self-developed control system seamlessly connects with the mainstream design software to fully satisfy the customer's individualization demand, easy to achieve intelligent production.

Parameter / Model	V-PC2518
Multi-function machine head	Easy to change different tool heads, with strokes, cutting, and other functions
Tool configuration	Active round knife tool, V punch tool, round hole tool, optional configuration of vibration knife, drag tool
Cutting speed	1200mm/s (depending on the cutting material)
Cutting thickness	30mm (depending on the cutting material)
Cutting material	Technical fabric, microfiber leather, velvet fabric, fur, PU leather, etc.
Material fixing method	Vacuum adsorption
Repeatability	+0.1mm
Software resolution	0.025, 0.01, 0.1 optional
Transmission port	NETWORK PORT
Network transmission distance	≤350 meters
Buffer capacity	2GB
CNC panel	Chinese and English LCD touch screen
Transmission system	Import (digital servo motor, linear guide, timing belt, screw)
Command system	HPGL compatible format
Total power	95KW
Rated voltage	380V+ 10%
Effective working range	2500*1600mm
Maximum rolling format	1650mm
Overall size	3600*2560*1265mm

SPREADER



V-KWS-210

Servo motor spreader machine for knit and woven

- The industry is the first full servo paving machine, the entire system and motor all use servo system, operation is more intelligent.
- The industry is the first to adjust the edge setting device, so that the paving effect is more flat.
- Humanized operation interface, with 40 kinds of fabric memory function.
- According to the actual situation of the fabric, any adjustment of each position of the fabric loose.
- The use of imported aviation antistatic materials. Solve the difficult problem of static cloth in winter thoroughly.
- Brake wire can automatically loop the function of opening and stopping. A key type automatic collection function, simple and convenient.
- Automatic memory attachment function, improve production efficiency.
- According to the actual situation of the fabric, the position of the opposite side of the zero point is set immediately.



V-AIR-ST-1.83x1.20

Complete set of block of air table size with blowing turbine



V-MS-S2-180

Semi auto spreader 1.8m width, with end cutter

Model	V-KW-190	V-KW-210
Power supply	1P/220V	
Motor	1kw	
Maximum cloth width	1900MM/75"	2100mm/83"
Table width	2130MM/84"	2330mm/92"
Machine weight	340kg	360kg
Weight of cloth roll	60kg max	
Diameter of cloth roll	450mm max	
Travel speed	90m/min max	
LxWxH dimensions(cm)	260x180x95	280x180x95
LxWxH packing volume(cm)	280x200x125	300x200x125
N.W./G.W	570/860kg	610/970kg
Spreading methods	One way 220mm Heightening 300mm(KW-H) Face to face 150mm Heightening 230mm(KW-H)	
Lay height	 ONE-WAY SPREADING (FACE UP)	 ZIGZAG SPREADING (FACE TO FACE)

Type	Width(mm)	Length(mm)	Height(mm)	Thickness(mm)	Others(mm)
Normal	1830/2130/ 2330/2530	1200	800-900	27-30	Customized
Flotation table				800-900	

FABRIC INSPECTION & RELAXING & LOADING



V-FI-185S

Fabric inspection for edge matching knit & woven

Product Overview:

- Fabric edge controlled by precise infrared electronic, ensure the material tidy and prevent stretching.
- Speed control 0~50m/min, fabric tension adjustable.
- With back and forward movement, auto fabric loading and feeding.
- Auto reset and auto stop, various color separation lamp.
- High quality transparency material and strong internal & external lighting, make sure every corner very clear.
- With high precise counter make records for fabric, can chose meters or yards.

Model	Power supply	Max.cloth with	Inspecting speed	Power	N.W/G.W	Machine dimensions	Measurement
V-FI-185S	220V/50Hz	1850mm(72")	0-50m/min	2.4kW	320/390kg	240x150x184cm	265x170x190cm
V-FI-225S	220V/50Hz	2230mm(88")	0-50m/min	2.4kW	390/460kg	280x150x184cm	305x170x190cm



V-FR-2

Fabric relaxing machine to eliminate the tension of knitting fabric, keep warehouse tidily

Product Overview:

- Fabric width reach to 80" (V-FR-2L reach to 88").
- Roller and rocker speed adjustable, with rewinding function.
- Movable wheels, also with option for counter yard (meter).

Model	Power supply	Fabric diameter	Fabric weight	Width of roller	Speed for inspection	Wagging width	N.W/G.W	Machine dimensions	Measurement
V-FR-2	1P/22V	500mm	80kgs	80"	0-80yards/min	60cm	170/200kgs	245x80x120cm	253x80x142cm
V-FR-2L	1P/22V	600mm	100kgs	88"	0-80yards/min	60cm	185/230kgs	265x80x120cm	277x80x142cm
V-FR-2M	1P/22V	500mm	150kgs	80"	0-80yards/min	100cm	230/260kgs	288x96x135cm	288x96x145cm



V-FL-200

Loading fabric device

LxWxH Dimension	2700x1000x2100mm;3000x1000x2100mm
Max. cloth Weight	200KG
Max. cloth Roll Diameter	800mm
Max. loading Height	1.6mm
(LxW)max. cloth Roll Dimension	2100x800mm;2400x800mm
Max. cloth Roll Diameter	AC 230V±5%

FABRIC SHRINKING & FORMING / TRANSDUCTION BIAS CLOTH REWINDER / ALIGNING & FOLDING STITCHING MACHINE



V-20000II

Senior double conveyor garment fabric shrinking and forming machine

Product Overview:

- Check which model you need, we have steam humidification zones, one drying & setting zone, or one cooling & setting zone.
- Sensor monitor the process of cloth entry, cloth roller adjust by screw.
- Heating system by electric, top and bottom steam is circulation.
- Steam temperature 125-185 degree, cooling system is powerful.
- Auto fabric conveying device keep a certain vertical arc between fabric and conveyor, make sure the fabric without tension.
- Suction hood device absorbs residual steam to keep workplace fresh.
- Fabric unloading device through swinging rocker arm to fold cloth.
- Length measurer inform accurately length and shrinkage.
- With fabric vibration device.

Model	Shrinking width	Conveyer form	Steam consumption	Conveyer speed	Adjustable temperature limits	Footage measurement	Power	Measurement	Voltage
V-20000II	2050mm	High temperature mash conveyer belt	150kg/H	0-40y/min	125°C-185°C	Imported Yard Meter	20.5kw	530x268x235cm	380V 50Hz



V-SL-680-2A

Multi-function transduction bias cloth rewriter

Product Overview:

- Suitable for non-woven material, leather, oxford fabric, knitting and woven fabric;
- To install, slitter & bundler degree twill scotching;
- Twill fabric winding can be adjusted between 30 degrees and 60 degrees;
- With meter stopwatch;
- The speed of fabric winding is adjustable as you want

Maximum operation width	2100mm
Motor power	1.2KW
voltage	220V/280V/50Hz
Measurement	2650x1060x230mm
Rewinding speed	0-40y/min
Maximum roll diameter	Φ400



V-SL-315

Automatic aligning & folding stitching machine

Product Overview:

- Together use with the twill fabric winding machine and strip cutting machine, replace the edge cutter sewing machine and manual folder and re-sewing;
- Suitable for garment factory front process, or accessories material or cap factory;

Fabric Width	700mm-1800mm
Folding Speed	6-10y/min
Voltage	220V/50Hz
Power	0.8kw
Measurement	3580x2200x1570mm

Extra width available upon demand

PLOTTER



V-J1850-2 / V-J2250-4
Basic type plotter



V-J2050-2-HP88
Continue supply Inkjet plotter



V-F1850-2 / V-F2250-4
With cover



V-LH1850-2
High speed and top class plotter



V-J1200PHQ
Cutting plotter



HP45 ORIGINAL
could add ink by yourself

PLOTTER PARAMETER DATA



Model	V-J1650-2 V-F1650-2	V-J1850-2 V-F1850-2	V-J2050-2 V-F2050-2	V-J1850-4 V-F1850-4
Inkjet Head	HP THERMAL INKJET HEAD (600dpi)			
Printing Density	300-600DPI Best mode: 600dpi Draft mode: 300dpi (sace-ink Moda is Optional)			
Scanning Speed	100Sqm/Hr 300-600DPI	100Sqm/Hr 300-600DPI	150Sqm/Hr 300-600DPI	200Sqm/Hr 300-600DPI
Upgrading	Can be Upgraded to 3 Heads	Can be Upgraded to 3 Heads or 4 Heads	Can be Upgraded to 4 Heads	
Line quality	Works Precisely Smoothly, And No Gap Between Two Contiguous Sections.			
Software Compatibility	HPGL (Special Format Can Be Back-ordered)			
Paper Feed System	Accurate Tracking System And Inside Digital Sense System Insure Marker Papers Feed Continually And Accurately More Than 606Long.			
Paper Installation Mode	Front Or Back Paper-supply System Is Optional.			
Paper Take-up Mode	Take-up automatically or manually Can plot many a mass of short marker, and save a lot of time for taking-up paper. On automatic taking-up method, it can work for overnight printing.			
Structure of Mainframe	US Style, Integrate, Full Metal, High Rigid, And Hard-wearing Structure, Insure The Machinery Lift span Is Longer 5 Times And Up Than Other Similar Products.			
Super Configuration	<ol style="list-style-type: none"> 1.High-speed Servo Control, Closed-loop Positioning In Whole Procedure 2.Own Independent Manager For Background Printing And Files Queue Automatically 3.Detect Available Area Of Paper Automatically For Plotting 4.Ink-costing Prompt And No-paper Alarm 5.Memorize Position Of Present Plotting Automatically When Plotter Stop Exceptionally In Working 6.Network Printing Is Available 7.Real-time Monitor Every Status Of Motion 			
Intelligent Cartridge	Memorize Original Point Automatically, Electronic Spring Fit Paper Automatically, Pen-down Accurately And Plot Clearly.			
Max. Width Of Paper	200CM	220CM	238CM	220CM
Max. Plotting & Cutting Width	165CM	185CM	205CM	185CM
Power Availability	90/264V, 47/66Hz			
Paper Availability	Ordinary Paper			
PC Interface	USB2.0			
Operation Keypad	Digital Touchpad, Operating Is Easy, Simlpe And Hard-wearing.			

• Notice: The Above Configuration Is Maybe Changed Without Notifying.

FLAT BED INKJET CUTTING MACHINE



V-P1512/V-P1509/V-P1209/V-0912

Flat bed inkjet cutting machine

Product specifications	V-P1512	V-P1509	V-P1209	V-0912
The job area	150cm×120cm	150cm×90cm	120cm×90cm	90cm×120cm
The drawing area	600mm/s			
The drawing area	600mm/s			
Cutting speed	85m ²			
Inkjet Speed	600dpi			
resolution	1.5mm(Special specifications can be customized)	motion	The uniform velocity of the linear curve	
Enter the format	HPGL(Special specifications can be customized)	Paper loading system	Rear all-in-one/split (optional) paper collection system	



V-DAO
Digitizer



V-DCO
Digitizer scanner

POCKET CREASING & TURN MACHINE



V-PK101
Pocket creasing machine
single head



V-PK201
Pocket creasing machine
double head



V-DF01A
Collar Band Turn Machine

Product Overview:

- Turn over for decorative strip, shoulder loop, sleeve loop of all kinds of clothing (such as swimming cloth, windbreaker, heavy coat) after the sewing;
- Can improve efficiency 2-7 times;
- With 14-32mm, length < 1m;

100-265VAC 50/ 60Hz;
0.45-0.75MPa;



V-QF02
Collar turn+block machine

Product Overview:

- Suitable for pressing collar Angle of shirt with various fabrics;
- Can be operated by one or two people at the same time;
- Using pedal control press. Press time can be set freely, safe and reliable;
- Automatically stop heat if without operation for long time;
- 100-265VAC 50/ 60Hz, 0.45-0.75MPa, 350W, 50-200°C.

V-DF01B
Thick Stuff Turn Machine

Product Overview:

- Turn over for decorative strip, shoulder loop, sleeve loop of all kinds of clothing
- OR cleaning products after the sewing.
- Flat cloths with sharp corners, rounded corners, polygonal loops, etc.
- Can improve efficiency 3-5times.
- With 20-200mm, length 20-150mm;



100-265VAC 50/ 60Hz;
0.45-0.75MPa;

V- FZJ01
Glove Turn Machine

Product Overview:

- Suitable for all kinds of labor protection canvas gloves to automatically turn over fingers and face after sewing, reducing labor intensity.
- Can improve efficiency 2-3 times.
- 100-265VAC 50/ 60Hz; 0.45-0.75MPa;



FUSING MACHINE



V-F450B / V-F500B / V-F600B
Automatic belt warping prevention fusing machine with limit switch, motor and sensor for adjust belt transporte brush motor



V-F400CS / V-F500CS / V-F600CS
Fusing machine basic type with seamless belt



V-F900Q / V-F1000Q / V-F1200Q
Fusing machine with double roller and double pressure device



V-F900L
Fusing machine with longer transoport system



V-F1600L-FC/V-F1800L-FC
Fusing machine with fabric roller



V-FX613
Leather shoes lining fusing machine

HEAT TRANSFER MACHINE



V-38x38
Manual basic one



V-38x62
Manual basic one



V-38x82
Manual basic one



V-40x50TR
Sleeve type



V-1010S / V-1515S / V-2020S / V-2525S
Movable Double head label transfer pneumatic type



V-4060S
Heat transfer machine Pneumatic, double working plate, automatic movable from upper



V-4060S1
Automatic movable double head pneumatic type



V-60x80S1
Heat transfer machine Pneumatic big size, double working plate, automatic movable, 60*80cm

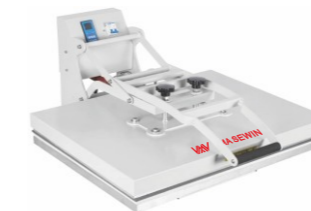

V-60x80
Big size



V-80x100
Big size



V-80x100S2
Big size front back movable



V-100x120S2
Pneumatic big size front back movable



V-CP8x15
Cap heat press machine



V-38x38JC
8 in 1 combo type



V-CH-4060QC
Side move type

Model	Bonding width	Upper conveying	Lower conveying	Speed	Pressure	Temperature	Power	Weight	Measurement
V-F400(500/600)C	400/500/600mm	1530mm	1840mm	10m/min	0.3MPa	≤190 degree	4.8/6/7KW	160/176/194kg	105x75(95/105)x74cm
V-F450(500/600)B	450/500/600mm	1530mm	1660mm	10m/min	0.15MPa	≤190 degree	5.6/5.6/7KW	198/198/218kg	101(101/110)x90x90cm
V-F900Q52	900mm	3700mm	3770mm	10m/min	0.4MPa	≤190 degree	22.5KW	500/550kg	319x140x151cm

PAD PRINTING MACHINE SERISE



V- PMO-80

Pneumatic monochrome oil cup pad printing machine

Product Overview:

Maximum print speed: 2400pcs/hr
 Plate size: 100x225mm
 Pad size: 90
 Maximum print area: 80x80mm
 Head lift Z movement: 150mm
 Plate X movement: 125mm
 Power: 220V 50HZ 50W
 Air cinsumal: 130L/min

PRESS MACHINE



V-SP801
Steam press machine



V-SP801E
Steam press machine

With 4 different size: 26" 32" 36" 40" inch



V-SP801T
Steam press machine



V-SP8801
Steam press machine



V-SP610
Pans press



V-PMO-150-4

Pneumatic Conveyor Belt Four Color Pad Printing Machine

Product Overview:

This series pad printing machine adopts oil basin type oil supply system, microelec tronic keyboard control operation interface, independent rubber head down stroke and speed control, independent steel plate position fine-tuning function, equipped with direct push shuttle platform or belt type workbench. It has the characteristics of multi-color printing, precise setting and easy operation. Widely used in hardware, plastic and other industries. Such as the cartoon pattern printed on toys, stationery, electrical appliances, gifts.



V-CT/338T

Household hang steam iron machine, double temperature, adjustable hanger Red



V-CT/118T

Household hang steam iron machine, double temperature, adjustable hanger Red / Yellow / Green



V-CT/528T

Household hang steam iron machine, double temperature, adjustable hanger Peach red / blue



V-CT/518T

Household hang steam iron machine, double temperature, adjustable hanger, with clamp for trouser, anti-hot gloves, sleeve ironing board

SHIRTS COLLAR & CUFF MACHINE



V-CU122

Cuff block machine, the cuff mode with the stretch system which is easily change to different pattern; 300PCS/Hour.

Features:

- For cuff block after stitch;
- Programmable computer control system to effect continuous work cycle;
- Temperature and time are adjustable;
- The cuff mode is with the stretch system which is easily change to different pattern;
- Semi or full automatic control by choice;



V-CPB112

Collar Trim / Turn and Block Machine automatic and pneumatic mode for collar angle trim, turn and block ; Left and right collar pressing buck in one machine; 200PCS/Hour.

Features:

- Collar trimming,turning and blocking, with automatic stacker,high efficiency
- Left and right mold heating temperature and pressing operate time are adjustable respectively
- Automatic or semi-automatic operation
- PLC automatic circulation control system
- Collar cutting knife angle is adjustable,to ensure collar sharp and thin
- Automatic arm to fix the collar position to enhance efficiency,capacity 1800-2000 pcs collar
- With safety function



V-CP112

Collar Point Trimming and Turning Machine Automatic and pneumatic mode for collar angle trim, turn, separate working station; 250PCS/Hour.



V-STF501

Automatic and pneumatic mode , for collar block; Separate working station; Left and right collar pressing buck in one machine; 250PCS/Hour.



V-HY-B375

Front Placket Fold and Forming Machine For front placket automatic folding and pressing; Excellent suction design for automatic placket folding

Model	Power	Voltage	Compressed air pressure	Weight	Measurement
V-CPB112	3000W	220V/50HZ	0.4-0.5MPA	150kg	950x1250x1250mm
V-CU112	2200W	220V/1P/50HZ	0.6MPA	100kg	950x850x1250mm

FINISH MACHINE



V-T560-3KWA

Thread sucking machine

Product Overview:

- It aims at the design for various fashions, shirts, Western-style trousers, skirts. It enhances the quality, increases the output, it is time & labour-saving.
- The fierce air suction can remove the thread tip, dust etc, it makes the clothes appear more bright and attractive.
- Visible object worktable, extra-long air suction, easy operation.
- Low noise.

MODEL	Table size	Air suction pressure	Rated power	Work table height	Power supply	Weight	Out line dimension (L×W×H)	Packing size
V-T560-3KWA	4800m ² /h	< -350Pa	3KW	850mm	380V/3PH/50Hz	165kg	1550x1440x680mm	905x765x1570mm



V-TKJ101

Pants finisher

Product Overview:

- Precision control feature allows the clamping means trouble-free ironing trousers highly sensitive fabrics without any damage.;
- Easy height adjustment, the pedal points three adjustment (with optional adjustment means for shorts);
- Carriage running smoothly, improve the quality ironing;
- Can ironing waistband width 480-1430mm / 19-56 inch pants, without any adjustment;
- Pants with two-way semi-circle tension, to further improve the quality of ironing (optional waistband tensioning device);
- No wear long trousers tensioning device life cycle;
- Air pressure from the optimum air flow control system to ensure understanding of the effect of ironing;
- Modular control system enables the host and waistband longitudinal or transverse tension have more choice to use a combination of function;



MODEL	Output	Steam	Condensate water	Vacuum	Air compression	Voltage	Weight	mm (in)	Packing size
V-TKJ-101	100 PCS/H	5-7.5Bar	0.5Bar	1.5KW	0.7MPa	380V	190kg	850x850x1750mm	1100x1000x2000mm

IRONING TABLE



V-TDZ-B1
Vacuum ironing table



V-TDZ-B1S
Lifting and Vacuum ironing table & blowing



V-TDZ-B1-2SW
Double swing buck

Product Overview:

- The net shelf is made of stainless steel, rustless and more longer life.
 - Holey sponge, good of quality and ventilate strong suck-wind.
 - The noise lower than commonly product, easily operate.
 - All series can add-ons; Electric tubes, Vacuum outlet, Hanger.
- You can choice between vacuum and blowing function.

MODEL	V-TDZ-B1
Table size	800x1200mm / 800x1500mm
Vacuum motor power	750W
Vacuum perssure	<-150Pa
Table top heating power	1000W
Buck heating power	350W
Rotational speed	2800r/min
Packing size Table top	1242x1000x 165mm/ 1542x1000x165mm
Body	580x490x660mm
Buck	870x270x190mm

Model NO.	Plane figur	Rotating base	Electronic heat	Remarks
A			•	For click pedal iron table TDZ
B				
C			•	
D				
E			•	For U-shape iron table U-Shape
F				
G			•	
H				
I				For normal iron table TP-B4
J				For normal iron table TP-B6

IRONING TABLE



V-TDG-B1
Vacuum ironing table with
build-in steam generator



V-TD-BE
Normal vacuum ironing table

MODEL	V-TDG-B1	V-TD(Z)S-B1	V-TP-B4
Table size	820x1220mm / 820x1500mm	820x1220mm / 820x1500mm	650x1200mm / 700x1400mm 800x1500mm / 900x1800mm / 1100x2000mm
Table height	800mm	-	-
Generator heating power	4.5KW / 6KW	-	-
Generator pump power	550W	-	-
Vacuum motor power	750W	750W	550W
Vacuum perssure	<- 150Pa	<-150Pa	<-150Pa
Table top heating power	-	1000W (Optional)	-
Buck heating power	-	350W (Optional)	-
Rated steam pressure	0.4MPa	-	-
Rated evaporation rate	6kg/h / 9kg/h	-	-
Power supply	220V/1PH 380V/3PH/50Hz	-	220V/1PH 380V/3PH/50Hz
Rotational speed	2800r/min	1000-3000r/min	1400r/min
G.W.	142 /145kg	-	-
Out line dimension (LxWxH)	-	-	-
Packing size Table top	1240x 1000x 165mm / 1542x1000x165mm	1600x420x280mm	1240x750x150mm / 1442x790x150mm / 1540x850x150mm / 1840x910x510mm 2040x 1140x150mm/2042x1142x150mm
Body	945x550x740mm 1945x550x740mm	780x460x750mm	-
Buck	870x270x190mm / 870x270x 190mm	870x270x190mm	700x500x680mm
Chimney	450x320x250mm	-	670x265x200mm

U SHAPE IRONING TABLE



V-TDZ-Q1

U shape vacuum ironing table 39*120cm, height 80cm



V-TDZ-Q2-CH

U shape vacuum ironing table 39*120cm, height 87cm, with chimney



V-TDZC-Q3

U shape vacuum & blow ironing table 39*120cm, height 90cm, with blowing motor

MODEL	V-TDZC-Q3
Table size	390x1200mm
Vacuum motor power	550W
Blow motor power	120W
Vacuum perssure	< -150Pa
Blow pressure	> 80Pa
Table top heating powe	1300W
Buck heating power	350W
Noise	≤72DB(A)
Power supply	220V/1PH 380V/3PH/50Hz
Rotational speed	2800r/min
Packing size	1490x550x1080mm

U SHAPE IRONING TABLE



V-TDZG-Q3

Vacuum ironing table with build-in steam generator

Product Overview:

- Large air suction, low noise, it does not contain water, fine shaping effect, choice material, the spares and parts adopt the superior products, it is fit for the ironing of the lady's dress.
- The stand is equipped with a special electric heating steam boiler, which can realize the complete automatic control of air pressure and water level, and can ensure the pressure and steam volume of the steam required by the iron.
- Stainless steel furnace.

Model	Table size	Vacuum motor power	Vacuum perssure	Table top heating power	Buck heating power	Generator pump power	Noise	Power supply	Rotational speed	Weight	Packing size
V-TDZG-Q3	400x1200mm	550W	< -150Pa	1300W	350W	2.5kW	≤72Db(A)	220V/1PH 380V/3PH/50Hz	2800r/min	107kg	1490x59x1120mm



V-TDZ-K

U shape ironing table

Product Overview:

- Special ironing table for trousers.
- Punching breathable foam texture, good breathabilit, strong suction.
- Lower noise, the operator is not easy to fatigue.
- Pedals can be placed on both sides, easy operation.
- Used for clothing industry, laundry.

Model	Table size	Vacuum motor power	Vacuum perssure	Table top heating power	Noise	Power supply	Rotational speed	Packing Size Table top	BODY
V-TDZ-K	150x1200mm	370W	< -150Pa	1000W	□720b(A)	220V/1PH 380V/3PH/50Hz	2800r/min	1480x420x220mm	495x400x615mm

SUIT PANTS HEAT IRONING MACHINE SERIES



V-QW460

Machine for remove globular shape and lump besmirch from cloth



V-HY-BH

Computerized plate clip ironing machine



V-HY-BF

Computerized common use clip ironing machine

Model	Voltage(V)	Power(KW)	Steam Wastage(Kg/h)	Air Pressure(M/pa)	Packing Size(cm)	Volume(KG)
V-HY-BF	220V	4.8	20	0.45	135x128x135	460
V-HY-BH	220V	1.6	10	0.45	121x125x111	220

IRON



Gravity Feed Iron Series



TYPE4

- Streamlined beautiful design;
- Convenient Soft button for steam;



V-300LS

- Ceramic spray heating plate, wear-resistant and long life;
- Integrated heating plate, greatly improving steam quality.



TYPE5



V-IR300L



HS94



V-600

Electric Steam Iron Series



TYPE5



V-IR300L

All Steam Iron Series



V-200



BSP-600



HS-6PS



HS-BSP-300



V-IR6PC



V-800L



HS-B3

AUTO BASEBALL CAP IRONING MACHINE



SHIRTS HEAT IRONING MACHINE SERIES



V-LZ-1-A1

Auto baseball cap ironing machine single head



V-LZ-1-A2

Auto baseball cap ironing machine double head



V-LZ-1-D2

Auto baseball cap ironing machine 4 head cold & hot both



V-LZ-4-3

Cap eyebrow bending machine 4 heads cold & hot both



V-LZ-6-1

Automatic cap top plastic button cover machine



V-LZ-1-D3

Multifunctional machine front piece/bend eyebrow/ironing 3functions in 1 together



V-LZ-3-2

Cap front piece press machine 2 heads, steam type



V-LZ-4-2

Cap eyebrow bending machine 4 heads



V-LZ-6-2

Automatic cap button attach machine



V-LZ-7-1

Automatic transport line 4 meters

ELECTRICALLY HEATED STEAM BOILER



V-ST-21A

Mini steam generator with iron



V-ST-01A

Electrically heated steam boiler smart steam generator



V-ST-009

Electrically heated steam boiler smart steam generator



V-ST-F3

Intelligent voice speaking energy saving steam generator

MODEL	V-ST-21A	V-ST-01A	V-ST-009	V-ST-F3
Heating power	1.2KW	4KW	4KW	5KW
Water adding mode	Manual watering	-	-	-
Reated steam pressure	0.4MPa	0.4MPa	0.4MPa	0.4MPa
Rated evaporation rate	4.0kg/h	5.7kg/h	5.7kg/h	6.5kg/h
Nomal water volume	2.2L	5.4L	5.4L	5.4L
Full water volume	3.8L	7.8L	7.8L	7.8L
Rated steam temperature	151°C	151°C	151°C	151°C
Iron	Electric steam iron	Full steam iron	Full steam iron	Full steam iron
Power supply	220V/1PH/50HZ	220V/1 PH/50Hz	220V/1 PH/50Hz	220V/1 PH/50Hz
G.W.	12.5kg	20/23kg	20/23kg	20/23kg
Out line dimension (LxWxH)	525x315x400mm	890x465x365mm	890x465x365mm	890x465x365mm

ELECTRICALLY HEATED STEAM BOILER



V-DLD3-0.4-A1

Electrically-heated steam boiler, full automatic



V-DLD6-0.4-B2

Fully automatic electrically-heated steam boiler



V-DLD6-0.4-B3

Electrically heated steam boiler fully automatic boiler



V-DLD6-0.4-F3

Electrically heated steam boiler fully automatic boiler



V-DLD6-0.4-F4

Electrically heated steam boiler energy saving fully automatic boiler



V-SE-4/10/20/30

High-frequency electromagnetic steam generator

Model	Heating power	Nomal water volume	Full water volume	Reated steam pressure	Rated evaporation rate	Rated steam temperature	Iron	Power supply	G.W.	Out line dimension (LxWxH)
V-DLD3-0.4-A1	3KW	12L	26L	0.4MPa	4.5kg/h	151°C	Full steam iron	220V/1PH/50Hz	60kg	610x385x815mm
V-DLD12-0.4-B2	6/9/12KW	9L	18L	0.4MPa	9kg/h	151°C	Electric steam iron	220V/1PH/50Hz 380V/3PH/50Hz	55/70kg	480x550x1000mm
V-DLD6-0.4-B3	6KW	17L	29L	0.4MPa	9/12/17kg/h	151°C	Electric steam iron	220V/1PH/50Hz 380V/3PH/50Hz	58kg	480x550x1060mm
V-DLD-12-F3	6/9/12KW	17L	29L	0.4MPa	9/12/17kg/h	151°C	/	220V/1PH/50Hz	90kg	630x425x1100mm
V-DLD6-12-F4	6/9/12KW	21L	39L	0.4MPa	9/13kg/h	151°C	/	220V/1PH/50Hz	90kg	580x570x1460mm
V-SE4-30	3-6KW/8-12KW/ 18-24KW/28-32KW	/	6/10/14/20L	0.4MPa	7.5/14/28/40kg/h	151°C	/	220V/1PH/50Hz	90kg	530x660x1155mm

ELECTRICALLY HEATED STEAM BOILER



FULL AUTOMATIC GAS-FIRED STEAM BOILER



V-DLD18-0.4-A2(18kw)
Electrically heated steam boiler high power fully automatic boiler



V-LDR0.09-0.7-1 (48kw)
Electrically heated steam boiler huge power fully automatic boiler



V-LDR0.15-0.7-1A (120kw)
Electrically heated steam boiler huge power fully automatic boiler



V-SZS0.015-0.4-Q

Full automatic gas-fired steam boiler, rated evaporation rate 15kg/h



V-LNS-0.1-YC

Full automatic gas-fired steam boiler, rated evaporation rate 100kg/h



V-DLD24-0.4-F3

Electrically heated steam boiler huge power fully automatic boiler



V-LDR0.09-0.7-F3

Electrically heated steam boiler huge power fully automatic boiler



V-LDR0.15-0.7-F3

Electrically heated steam boiler huge power fully automatic boiler

Model	Heating power	Nominal water volume	Full water volume	Rated steam pressure	Rated evaporation rate	Rated steam temperature	Nominal size water inlet / steam outlet pipe	Power supply	G.W.	Out line dimension (LxWxH)
18-24KW	18KW	21L	40L	0.4MPa	22.5-30kg/h	151°C	/	380V/3PH/50Hz	108kg	800x530x1250 mm
36-72KW	24KW	74L	104L	0.4MPa	36/48/60/72kg/h	171°C	/	380V/3PH/50Hz	174kg	900x650x1370 mm
108-120KW	72/60/48/36KW	99L	134L	/	140/150kg/h	171°C	15/40mm	380V/3PH/50Hz	275kg	1000x720x1500 mm

Model	Rated steam pressure	Rated evaporation rate	Rated steam temperature	Nominal water volume	Full water volume	Applicable fuel	Used iron numbers	Power supply	G.W.	Out line dimension (LxWxH)	Packing Size
V-SZS0.015-0.4-Q	15kg/h	0.4MPa	151°C	10L	16L	(LPG)or(NG)	2	220V/1PH/50Hz	135kg	790x555x1220 mm	850x610x1330 mm
V-SZS0.028-0.4-Q	28kg/h	0.4MPa	151°C	13L	25L	(LPG)or(NG)	4	220V/1PH/50Hz	170kg	790x606x1195 mm	830x690x1330 mm
V-SZS0.05-0.4-Q	50kg/h	0.4MPa	151°C	21L	40L	(LPG)or(NG)	6	220V/1PH/50Hz	185kg	880x686x 1400 mm	855x970x 1580 mm
V-SZS0.08-0.7-Q	80kg/h	0.7MPa	171°C	29L	60L	(LPG)or(NG)	8	220V/1PH/50Hz	285kg	1300x 720x1360 mm	850x 1390x 1580 mm
V-SZS0.1-0.7-Q	100kg/h	0.7MPa	171°C	29L	60L	(LPG)or(NG)	10	220V/1PH/50Hz	285kg	1300x720x1360 mm	850x1390x1580 mm

Model	Rated evaporation rate	Rated steam pressure	Rated steam temperature	Normal working water volume	Water temperature	Exhaust temperature	Design thermal efficiency	Type of fuel	Gas consumption	Rated Power	Net weight of equipment	Shape size
V-LNS-0.2-YC	200kg/h	0.8MPa	176°C	29.8L	20°C	39°C	105%	LPG/NG	26.6m ³ /h 20.8kg/h	1.4KW	1450kg	1760x1100x1480 mm
V-LNS-0.3-YC	300kg/h	0.8MPa	176°C	29.8L	20°C	39°C	105%	LPG/NG	20m ³ /h 15.4kg/h	1.2KW	1300kg	1680x1100x1480 mm
V-LNS-0.5-YC	500kg/h	0.8MPa	176°C	29.8L	20°C	95°C	97.2%	LPG/NG	14.5m ³ /h 11.2kg/h	1KW	1200kg	1760x1100x1480 mm
V-LNS-1-YC	1000kg/h	0.8MPa	176°C	29.8L	20°C	95°C	97.2%	LPG/NG	7.3m ³ /h 5.6kg/h	1KW	800kg	1280x960x1000 mm

NEEDLE DETECTOR

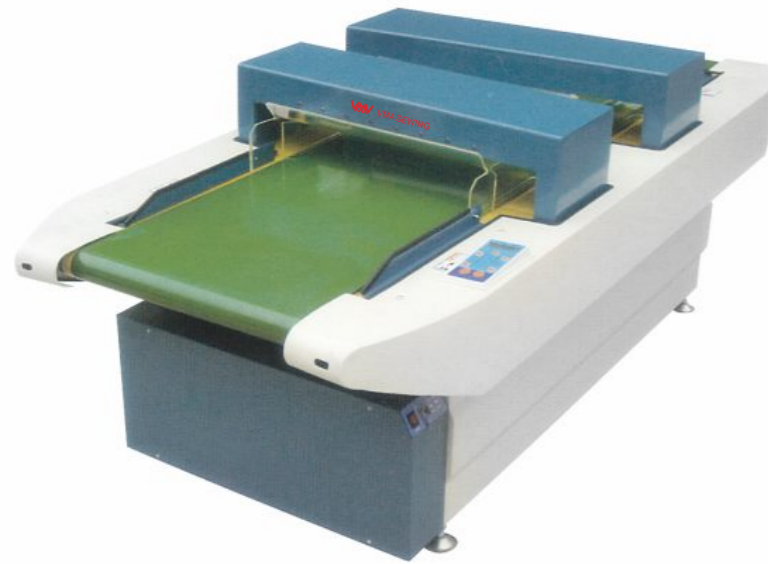

V-988V

Double head needle detector
Japan's PL needle inspection method
for general products needle requirements standards

Products	Standard
Bra sweatshirt socks	Φ1.0-1.2mm iron ball
sweater, shirt, suit, jacket.	Φ1.2mm
Sheets, towels, stitches.	Φ1.2-1.5mm
Down products	Φ1.5mm
Toys	Φ1.5-2.5mm

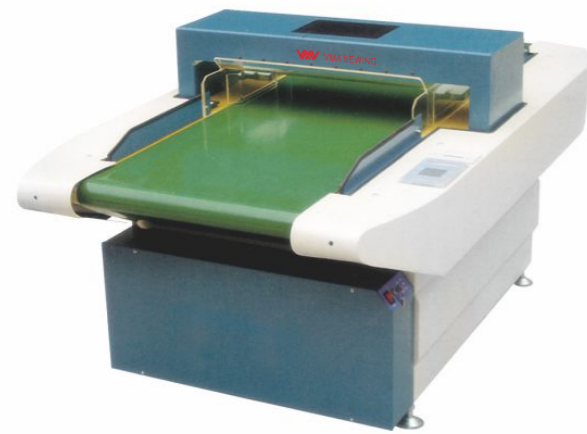

V-989

Needle detector with printing function



V-600C

Needle detector basic type



V-20MJ

Hand hold needle detector

Product Overview:

This instrument can continue to work for a long time, do not heat, do not produce overload phenomenon, applicable to large-scale needle detector detection, a small range of correct finding the exact part of the magnetic material of the steel needle, can achieve the correct and rapid exclusion of the purpose.

Power	Weight	Detection sensitivity	Volume
6F22-9V batteries	280g	1.2mm H10mm 0.7mm H50mm	13.5x6.5x3.5cm

EMBROIDERY MACHINE



V-1201N(600x400)

Single head new design, with thread lock system,
high speed 1200rpm

1. New Single head embroidery machine with 12/15 needles
2. USB input port with 8 languages
3. Cap frame, Cap hoops and Cap hoop station can be changed manually easily
4. Memory size 2000000 stitches
5. Electricity: 100v or 240v available
6. 1200 RPM Max speed
7. Compatible with designs of Wilcom and TAJIMA.
8. Japanese hook and bobbin with

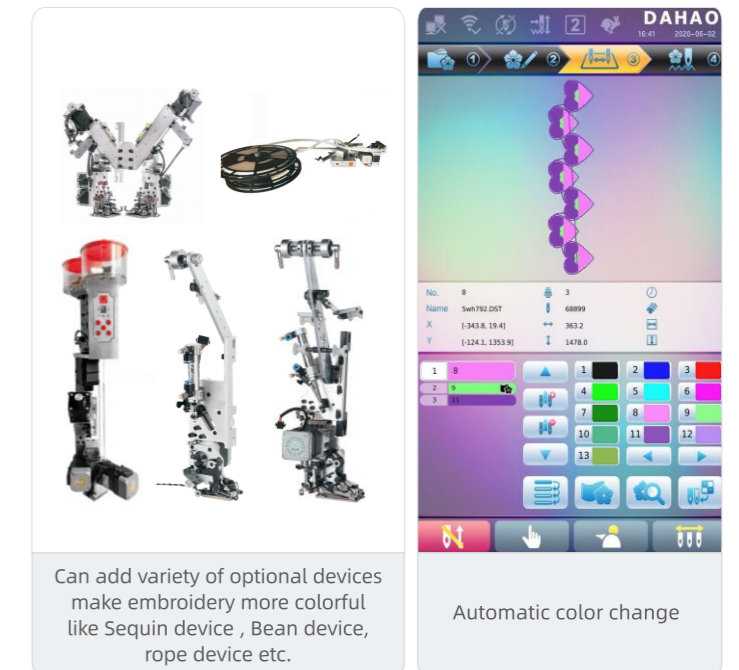

Can add variety of optional devices
make embroidery more colorful
like Sequin device , Bean device,
rope device etc.

Automatic color change



Sequin Device



Easy Cording Device



Belt Device



Trousers Tube Device



Shoes Device

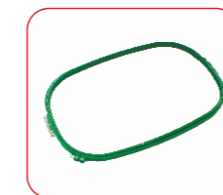

Jacket Back Square Hoop 37x51cmX1



Jacket Back Square Hoop 29x29cmX2



Shirt Front Round Hoop 22cmX2



Shirt Front Round Hoop 15 cmX2



Shirt Front Round Hoop 12 cmX2



Shirt Round Hoop 9 cmX2

EMBROIDERY MACHINE



V-1201N-MT

Mixed taping embroidery



V-TP701

Leather decoration embroidery machine, 7 colors

EMBROIDERY MACHINE



V-1202N

Double heads



V-1203N

Three heads



V-1201-mini

Light embroidery machine, 68kgs,12 needles



V-1201N-LS

Single head with laser



V-1204N

Four heads



V-1206

Six heads



This kind of machine is versatile use, such as Cap, T-shirts, flat, garment, socks, gloves, jackets, sleeves, bags and so on.



V-1208

Eight heads



V-1212

Twelve heads

COMPUTERIZED FLAT KNITTING MACHINE

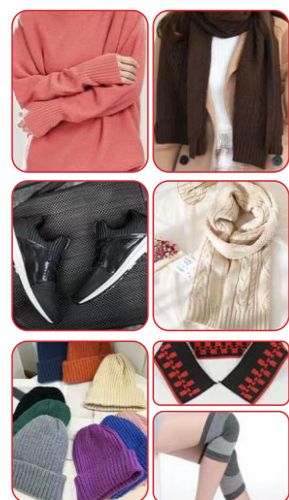

V-52S-2

Fully automatic computer knitting flat knitting machine, double system

Product Overview:



NOSE

The running stroke is automatically adjusted according to the width of the fabric; the adjustment is quick and the positioning is accurate, avoiding useless movement and greatly improving the production efficiency of the machine.



NEEDLE BED

The split structure adopts imported high-quality steel plate; fine milling reduces the resistance of acupuncture and pro-longs the service life.



YARN FEEDER

It can effectively reduce the resistance when conveying the yarn. It is especially suitable for fabrics with poor elasticity or brittleness, so that the fabric structure is uniform and the machine knitting efficiency is improved.



SIDE CREEL

Active storage of yarn can reduce the resistance of yarn movement, and is suitable for fabrics that lack elasticity and brittleness, such as cashmere yarn and rabbit hair yarn.

Gauge	2.5G/3G/3.5G/4G
Knitting width	60,66,72,80,88,100inch
Knitting system	dual system
Knitting function	Stitch Trasfer, independent suspension, pointelle, intarsia, jacquard, apparent or hide shaping and other regular or irregular patterns.
Knitting speed	Controlled by servo motor with 32 sections optional, Max 1.2M/S.The serve motor combines precise feedback control system with high-speed digital signal processor(DSP)to control IGBT to achieve accurate electric current output.
Racking system	Controlled by AC servo-motor,racking within 2 inches an with fine adjusting function.
Stitch density	Controlled by stepping motor, 32 sections stitch selectable adjustable scopesupported by subdivision technology: 0-650, the length of the knitwear can be accurately controlled.
Stitch transfer	Triangular integrated designing enables independent or simultaneous stitch transfer to realize more efficient production.
Roller system	Infrared alarm, Computer programs instruction, stepper motor control, 32-stagetension selection with an adjustable range between 0-100.
Yarn carrier	4 guide rails and 2*8 nozzles, shiftable at any postion of the needle bed.
Protection system	The machine alarm system will set off when yarn- breaking, knots, floating yarn,rewinding, end of knitting, racking failure, needle breakage or Program error, also set up the safety auto-lock protect device.
Control system	1.LCD touch screen, graphical interface. USB and network compatible, with expanded memory of up to 2G.A great amount of patterns can bestores and mobilized for use at any time as perproduction requirements. 2.Monitoring display: Various operating parameters can be displayed and can be adjusted anytime when the machine is running,making operations as convenient and time-saving as possible. 3.Design system and control system(software)are easy to update for free. 4.Multi-language operating system: Thereare Chinese, English, Spanish and Arabic Versions. Languages can be switched according to customer requirements.
Network function	High speed network can coordinate up to 250 machines; the knitting data can be uploaded downloaded and shared.
Power	Single- phase 110V/220V/three-phase 380V ,adopt advanced CMOS technology,having memorizing function at power shock stop.(Optional British plug)

MATTRESS MACHINE



V-FB3A-L

Tape edge machine electronic control, infinitely variable speed.With lockstitch head



V-FB3A-C

Tape edge machine electronic control, infinitely variable speed.With Chain stitch head

Model	V-FB3A-L	V-FB3A-C
Corner speed auto slow down		Yes
Sewing head type		Look stitch/Chain stitch
Working angle of the sewing head		33°-55°
Sewing thickness range of mat		30-330mm 130-430mm
Lifting of working table		Electric
Size of the working table		1400x2000mm 1600x2000mm 1800x2000mm
Sewing head speed		1100-3000 r/min select according to the type of sewing head
Carriage speed		5.5-10 m/min select according to the type of sewing head
Productivity		10-20 pcs/h
Motor type		singless three-phase motor
Power		1.12kW

V-KB4A

Multi function mattress overlock machine, maximum sewing thickness 80mm, Pegasus 5 thread original head

Model	V-KB1A	V-KB3	V-KB4	V-KB4A
Max sewing thickness (Sponge density <25)	40mm	60mm	70mm	80mm
Press foot lift	12mm	12mm	12mm	16mm
Sewing stitch			1-5mm	
Heedle spacing		15mm/20mm(Optional)		20mm
Humber of sewing threads				
Maxsewing speed	3000SPM		4000SPM	
Air pressure		0.6-0.8Mpa		
Sewing head type		JUKI	JUKI	PEGASUS
Upper feed belt available	No	Yes	Yes	No
Heedle bar type	Double-bar	Single-bar	Double-bar	Double-bar
Motor power		0.56kw		0.75kw



FULL AUTOMATIC FILLING MACHINE



V-FCE-2-8

Full automatic filling eider and cotton machine

Product Overview:

- 2 heads with 8 scale, each scale could weight 3-120g
- Suitable for 30-90 down fiber cotton
- Maximum storage 12kg cotton
- Auto change parameter according to small/middle/big weight
- Accurate 0.1g, less than 5% difference
- Cotton output 1-10g/s
- Take up 5x4m ground
- With 125000 different amount, each amount could use for 40 piece small square.

V-FCE-C-4-8

use more for cotton

V-FCE-1-2

Full automatic filling eider and cotton machine one head 2 scale

Product Overview:

- Suitable for 1-80g down fiber cotton.
- The non-contact weighing system is adopted to ensure high-precision and low-error cotton filling.
- The fully-closed design ensures a clean production site. This improves not only the work environment, but also the corporate image.
- The machine is controlled by computer programs, which means that different weights or quantities of cotton can be filled in different cells of the clothing.
- Key elements and components are all imported from developed countries to ensure the stability and reliability of the equipment.
- With the machine, one worker's operation efficiency is comparable to that of 4 or 5 workers.

V-FCE-C-1-2

For cotton filling 2-180g

V-FCE-M

Semi-auto filling machine, manual weight without scale.



FULL AUTOMATIC FILLING MACHINE



Model	V-FCE-1-2	V-FCE-2-2
name	one head two scales	two head two scales
feeding unitsize(m)	1.55×0.85×1.9	1.55×0.85×1.9
weighing unitsize(m)	-	-
worktop unitsize(m)	-	-
unit performs space(m)	2.0×2.5×2.5	2.0×2.5×2.5
the weight of equipment(kg)	200	200
filling material	Fiber cotton/granular cotton	50-90Down/Fly
filling pipes by filling station	1	1
filling storage(kg)	8	5
scales by filling pipe	2	2
filling range(g)	3-180	1-50
accuracy(g)	0.1	0.1
error range	5%	5%
air compressor(m³)	≥1	≥1
air dryer(m³)	≥1	≥1
air tank(m³)	≥1	≥1
intake	Main pipe≥ 1.2 inch PPR	Main pipe≥ 1.2 inch PPR
manual flow control	Optional	/
computer control flow	Optional	Optional
DTY-WCM-5 with water	Optional	Optional
DTY-WCM-S	Optional	Optional
worker table	Optional	Optional
worktop	Optional	Optional
Auxiliary Feeding Device	/	Optional

Model	V-FCE-2-4	V-FCE-TS-2-4
name	single side two head four scales	Bsingle side two head four scales
feeding unitsize(m)	1.75×1.1×1.9	1.75×1.1×1.9
weighing unitsize(m)	1.75×0.85×1.3	1.75×0.85×1.3
worktop unitsize(m)	-	-
unit performs space(m)	2.0×3.5×2.5	2.0×3.5×2.5
the weight of equipment(kg)	350	350
filling material	Fiber cotton/granular cotton	50-90羽绒/飞丝
filling pipes by filling station	2	2
filling storage(kg)	20	10
scales by filling pipe	4	4
filling range(g)	3-180	1-50
accuracy(g)	0.1	0.1
error range	5%	5%
air compressor(m³)	≥1	≥1
air dryer(m³)	≥1	≥1
air tank(m³)	≥1	≥1
intake	Main pipe≥ 1.5 inch PPR	Main pipe≥ 1.5 inch PPR
manual flow control	Optional	Optional
computer control flow	Optional	Optional
DTY-WCM-5 with water	Optional	Optional
DTY-WCM-S	Optional	Optional
worker table	Optional	Optional
worktop	Optional	Optional
Auxiliary Feeding Device	/	/

DOMESTIC MACHINE



Multi-function 12 stitches



V-HS1212



V-1003



V-577

Multi-function 24 stitches



V-988E



V-E300



V-6224

Electronic style



V-1118



V-2685A



V-2100



V-1118K



V-2685AK



V-2100K

DOMESTIC MACHINE



V-ES6

Big area domestic embroidery machine with 7" LCD screen

Product Overview:

1. Embroidery Area 200*280mm, speed 860rpm.
2. Built-in 312 types embroidery design,also support the USB input custom pattern,can quickly imported embroidery patterns, and could zoom/rotate/mirror/pan the design, support letter/pattern combination, embroidery progress is real-time tracking, 11 kinds of languages, support thread color display.
3. With extend plate for sewing function.Support 30 million stitches of patterns storage, support fast forward/back off embroidery.
4. Touch Panel LCD, 100-240V, 50/60HZ, 55W, 18.5/14.5kg, 670*545*555mm.



V-EM-S5

Household embroidery machinewith 7" LED screen

Product Overview:

- Embroidery area 100x235mm , speed 650rpm, 0-4mm stitch length, 0-7mm stitch width.
- Build-in 160 sewing designs and 96 embroidery designs, also support the USB input 700 designs and could zoom / rotate / mirror / pan the design, embroidery progress is real-time tracking, 11 languages, support thread color display.
- With extend plate for sewing function.
- Have white / purple/ pink / blue color.
100-240V 50/60HZ 45W, 8.5/12kg, 445x365x385mm.



V-1500B

Household embroidery machinewith 7" LED screen



V-DO302

Overlock sewing machine with 2 thread/ 3 thread/4 thread/small stitch length



V-328

Overlock sewing machine

HOT AIR SEAM MACHINE



V-T100A-B01

Hot air seam sealing machine, double step motor

Power	AC 220V 50/60Hz
Rated power	3.0KW
Temp Control	no segment adjustable, normal temperature~700°C
Speed	1~23m/min
Air Pressure	0.35~0.5 Mpa
Roller Width	Smooth surface 25mm standard type, other options such as steel grain, straight grain need special making, etc
Tape Width	Standard type 14mm~25mm, other widths can be freely selected according to customer needs
Lifting Distance	10~30mm
Size	1250mm×610mm×1550mm
NW	115kg



V-T100A-B07

Hot air seam sealing machine, higher & slop arm

Power	AC 220V 50/60Hz
Rated power	3.0KW
Temp Control	no segment adjustable, normal temperature~700°C
Speed	1~23m/min
Air Pressure	0.35~0.5 Mpa
Roller Width	Smooth surface 25mm standard type, other options such as steel grain, straight grain need special making, etc
Tape Width	Standard type 14mm~25mm, other widths can be freely selected according to customer needs
Lifting Distance	10~30mm
Size	1250mm×610mm×1550mm
NW	115kg



V-T380-WF

Seamless hot press machine

Power	AC 220V 50/60Hz
Rated Power	3.0KW
Air Pressure	0.35~0.5 Mpa
Heating Temp	Normal Temp~250°C
Bonding Time	1~99s adjustable
Working Size	380mm*380mm
Machine Size	920mm×680mm×930mm
NW	95kg

HOT AIR SEAM MACHINE



V-W02A

Roller Style Taping and Trimming Machine

Product Overview:

- Seamless sponge bra taping and hemming
- Seamless sportswear, swimsuit, sports taping and trimming
- Seamless hosiery, cuffs and arc series of seamless products taping and trimming

FEATURE:

- With cutting knife, guide groove preheating system, blowing hot air, to ensure high speed and stable quality
- 1.Independent speed adjusting system for the upper and lower belts, and can store ten shrinkage programs
 - 2.Independent temp adjusting system for upper and lower belts, air driers and guide belts with temperature stability of ±0.5 degrees
 - 3.The heating tank adjusts the temperature independently
 - 4.Digital visual adjustment of roller pressure
 - 5.Trim the fabric with a cutter
 - 6.7 "touch screen visual operation
 - 7.Can choose a variety of accessories or devices with production for different functions



V-W03D

Belt Style Long Arm Multifunctional Machine

Product Overview:

- Seamless beach pants taping and trimming
- Shirts and Yoga suits taping and overlapping
- Sleeves or V tape style garment joint lapping and taping
- All kinds of sports wear overlapping and taping
- Swing suit, riding suits overlapping and taping

FEATURE:

- U shape lower bracket, long bonding area, blowing both from up and down sides 3 heating system, fast speed
- 1.Independent speed adjusting system for the upper and lower belts, and can store ten shrinkage programs
 - 2.Independent temp adjusting system for upper and lower belts, air driers and guide belts with temperature stability of ±0.5 degrees
 - 3.The air blower independently adjusts the air volume and temperature
 - 4.The heating tank adjusts the temperature independently
 - 5.The belt pressure can be adjusted and digitized visually
 - 6.Touch screen visual operation
 - 7.Can choose a variety of accessories or devices with production for different functions



V-W06

Ultrasonic glue machine

Product Overview:

Medical protective clothing, chemical protective clothing, jackets, ski suits, mountaineering suits, military field suits, down jackets, raincoats, car covers, sportswear, casual wear, military tents, outdoor clothing, wetsuits, advertising balloons, seamless underwear, swimwear, sweatshirts and other functional clothing and products sealing processing and sewing.

FEATURE:

- The incision is not scattered, the ultrasonic cutter, the belt guide groove is preheated, and the hot air is blown to ensure high speed and stable quality
- 1.Independent speed adjusting system for the upper and lower belts, and can store ten shrinkage programs
 - 2.Independent temp adjusting system for upper and lower belts, air driers and guide belts with temperature stability of ±0.5 degrees
 - 3.The heating tank adjusts the temperature independently
 - 4.Digital visual adjustment of roller pressure
 - 5.Trim the fabric with a cutter
 - 6.7 "touch screen visual operation
 - 7.Can choose a variety of accessories or devices with production for different functions

Model	Speed	Pressure	Width	Standard machine size	Customizable size	Cutter speed	Heating tank width	Heating quantity	Power supply	power	Frequency
V-W02A	0-12M/min Adjustable	0.5MPa/5bar	0-15mm	15mm	5-20mm	5000R/M	0-20mm Adjustable	2个/pcs	220VAC	1000W	/
V-W03D	0-12M/min Adjustable	0.5MPa/5bar	0-25mm	20mm	20/25mm	/	Customized	3个/pcs	220VAC	1000W	/
V-W06	0-5M/min Adjustable	0.5MPa/5bar	0-20mm	15mm	45/55mm	/	0-18	1个/pcs	220VAC	1200W	28KHZ

ULTRASONIC MACHINE

TABLE & STAND

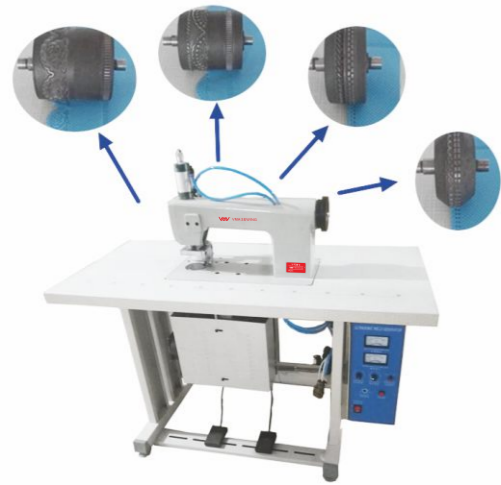

V-TC60-2

Ultrasonic machine with double motor, with air cylinder, inner side roller
Speed 0-18 meters per minuter, suitable for 23mm or
50mm roller, power 1500W, 220V 50/60HZ,
120/140kg, 128-x61x1270mm



V-TC60-PC

Outside roller for medical cloth



V-TC100-2

Ultrasonic machine with double motor,
with air cylinder, 100mm size



V-TC40

Ultrasonic point splicing machine
Frequency 20Khz, 220V 50/60HZ, Power
1500W, 80/90kg, 1280x610x1270mm

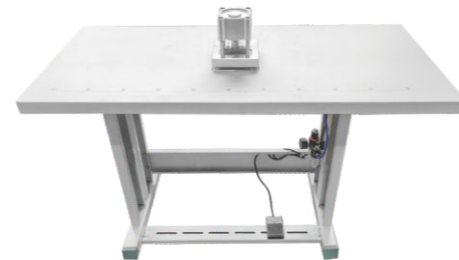

V-TC30

Punching hole machine for
non-woven bag



V-TC160

Ultrasonic quilting machine, 160cm width

Product Overview:

- No need thread and needle, use ultrasonic welding the fabric.
- Different rollers and patterns can be designed according to various materials and customer special requirements.
- 80 hours continuous working, easy to operate, high speed and productivity, powerful welding make sure the stable quality.



straight design



slop design

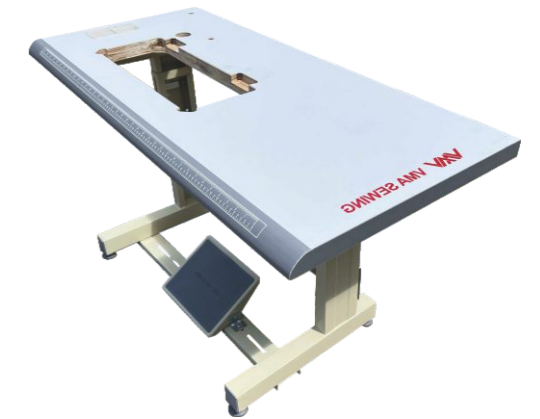

gray design



Italy design stand



Normal I type adjustable stand



Six legs stander for cylinder bed machines

MOTOR

PULLEY & DEVICE



V-MT550D-L
Change mechanical lockstitch to be direct drive with bobbin winder



V-MT550D-747K
V-MT550D-6700
V-MT550D-6800
V-MT550D-F007K
V-MT550D-MF7823U
Change mechanical overlock/interlock to be direct drive

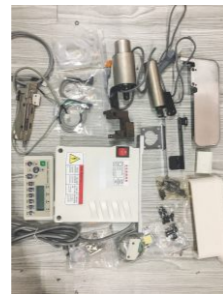

V-AT550D-6700E
V-AT550D-6800E
V-AT550D-747KE
Change overlock/interlock to be full function electronic control



V-AT550D-6700P
V-AT550D-6800P
V-AT550D-747KP
Change overlock/interlock to be full function pneumatic control



Electronic pulley

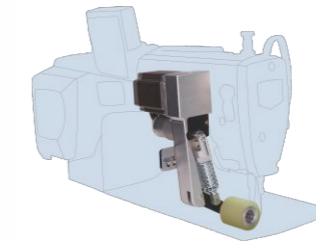

Lockstitch

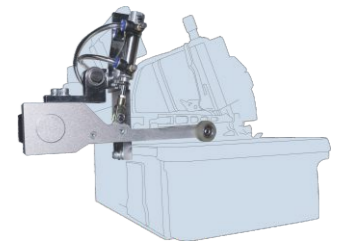

Overlock

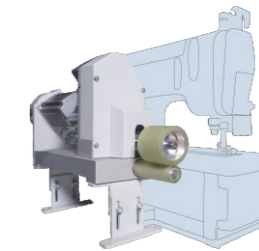

Interlock



MINI MOTOR
100W / 120W / 150W / 250W



INDUCTION MOTOR



CLUTCH MOTOR



V-M550W / V-M750W
Energy saving motor integrity small one



MK-MD/UT



ML-PL

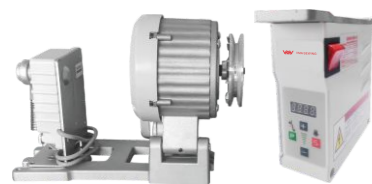

V-450W
V-550W
V-750W
Energy saving motor



V-450W-NP
V-550W-NP
V-750W-NP
Energy saving motor with external needle position



V-750W-105CM
Big puller



MC-E4

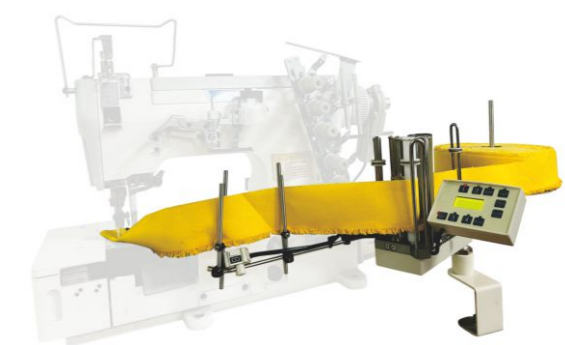

MC-M4L

CATALOGUE

JEANS

CATALOGUE

JEANS



V-T254-DNB
Double needle belt loop machine(PAGE 37)



V-9820
Eyelet button holing machine (PAGE 26)



V-818ATSE-4
Automatic snap button Attach machine(PAGE 44)



V-58750S-40S
Double needle electronic split needle bar(PAGE 26)



V-T2210MJ-ASN
J stitch machine(PAGE 45)



V-1002ATP
Full automatic button attach machine (PAGE 40)



V-63900L
Automatic trousers bottom hemming machine(PAGE 42)



V-969ATS-RPL
Belt pulley feed off the arm with automatic trimmer function(PAGE 38)



V-T2210D-LAC
Long arm pattern sewing for washing decoration(PAGE 34)



V-82000C
Two needles belt loop machine with front fabric cutting(PAGE 76)



V-1509P-WATC
Automatic waistband sewing machine (PAGE 43)



V-T2210D-FD3
Automatic waistband sewing machine (PAGE 33)



V-3800FAT-OR
Automatic pocket mouth curling machine (PAGE 42)



V-T1310D-APB
It is suitable for sewing leather tags or signs for luggage and clothes
The sewing range is 13x10cm(PAGE 33)



V-AO-3003B
Side seam serging for open seam style's(PAGE 46)



V-T3020ATPSL-7300A
Automatic pocket attach machine for jeans(PAGE 39)



V-88S
Automatic overlock 5 thread heavy duty machine(PAGE 17)

CATALOGUE

SHIRT

CATALOGUE

SHIRT



V-CPB112
Collar trim / turn and block machine(PAGE 121)



V-A7
Needle feed lockstitch machine (PAGE 06)



V-1790
Button holing machine (PAGE 27)



V-8558D
Chain stitch machine (PAGE 10)



V-9000S
Single Step motor electronic lockstitch(PAGE 03)



V-885
Full automatic overlock electronic control(PAGE 17)



V-438D-P918
Auto feeding button attach machine(PAGE 31)

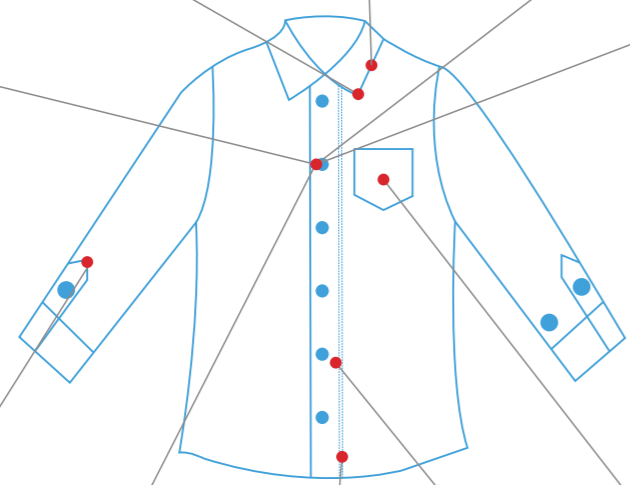

V-1795FAT
Full automatic button holing machine (PAGE 48)



V-927D
Feed off the arm machine(PAGE 28)

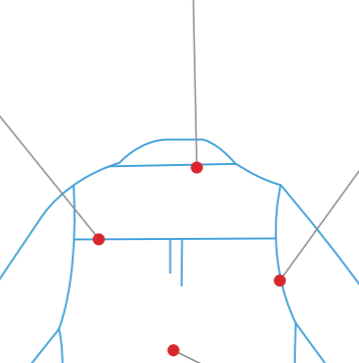

V-CU112
Cuff block machine(PAGE 121)



V-T7300A-5009B
Automatic sleeve placket machine (PAGE 47)



V-T9000ATP-QC
Quick change mould automatic pocket attached machine for knits and shirts, JUKI head (PAGE 48)



V-5490N-7
Differential feeding lockstitch(PAGE 12)

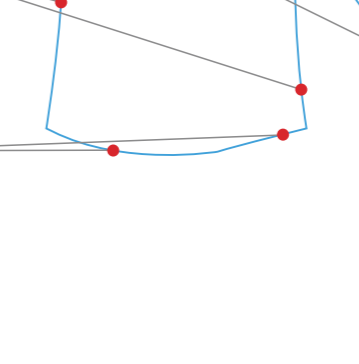



V-STF501
Automatic and pneumatic mode , for collar block; Separate working station; Left and right collar pressing buck in one machine; 250PCS/Hour(PAGE 121)



V-1903AT-MB06
Full automatic button continue attach machine(PAGE 49)



V-58750S-405
Double needle electronic split needle bar(PAGE 26)



V-HY-B375
Front Placket Fold and Forming Machine For front placket automatic folding and pressing; Excellent suction design for automatic placket folding(PAGE 121)

CATALOGUE

T-SHIRT



V-9000S
Single Step motor electronic lockstitch(PAGE 03)



V-5878-58N
Automatic placket wetting machine(PAGE 51)



V-438D-P918
Auto feeding button attach machine(PAGE 31)

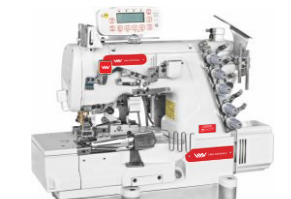

V-562D-02ATx364
Tape binding interlock with auto cutting tape device(PAGE 23)



V-T7300ATP
Automatic pocket attach machine for T-shirts(PAGE 48)



V-1790
Electronic button holing(PAGE 27)



V-88S
Full automatic overlock electronic control(PAGE 17)



V-430EQ
Electronic bar tacking machine control box build in(PAGE 30)



V-W500APW-BHR
Automatic T-shirt bottom hemming machine(PAGE 50)



V-88S-AT/BK
Full automatic overlock electronic control(PAGE 17)

CATALOGUE

SPORTS WEARS



V-997TD-4-ATE
Automatic feeding for circular collar setter(PAGE 20)



V-88S
Full automatic overlock electronic control(PAGE 17)

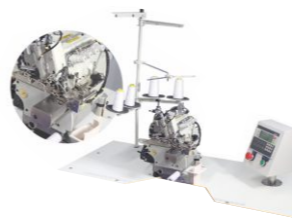

V-997TD-4-ATSX
Automatic sleeve setter overlock cylinder bed machine(PAGE 20)



V-1790AT-2H
Button holing machine with auto feeding device open string hole(PAGE 27)

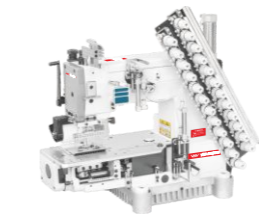

V-008VCE-12064P
Multi-needle cylinder bed . with auto trimmer(PAGE 74)



V-32-2-90
high speed braiding machine



V-F6021AST
Automatic string thrusting machine(PAGE 60)



V-008VCD-12064VPL-AT
Multi needle tape attach machine with automatic device

CATALOGUE

SUITS

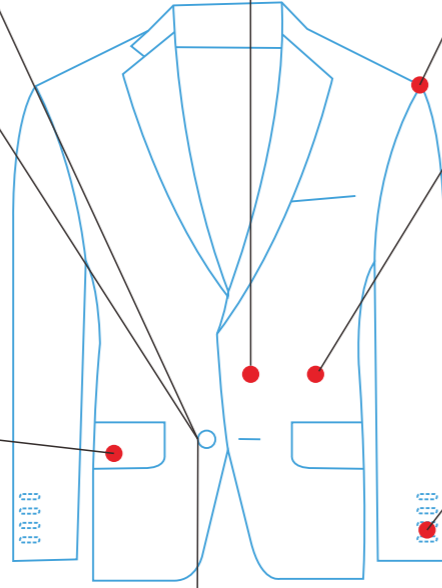

CATALOGUE

SUITS

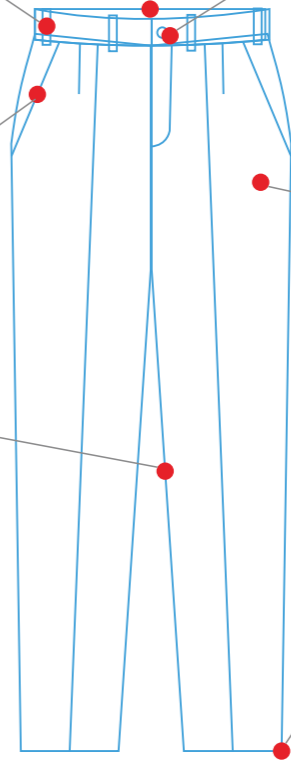
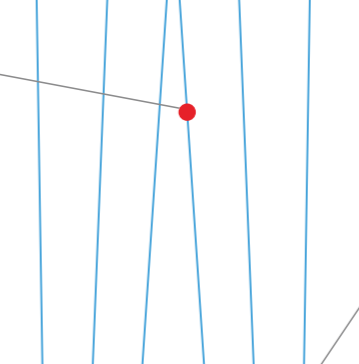
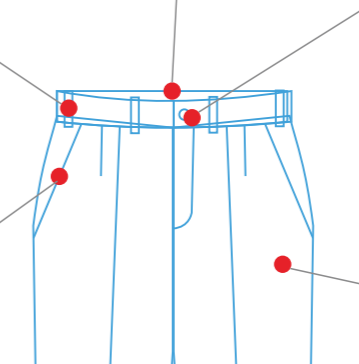

CATALOGUE

UNDERWEAR

CATALOGUE

UNDERWEAR



V-A2-D
Bra pad molding machine



V-2284D-7/P ZIGZAG
ZIGZAG 1 step 2 points electronic
(PAGE 62)



V-562D-05CBx364
Interlock machine with right side
knife for lace(PAGE 23)



V-T1008G-09XJ
Automatic elastic ribbon
splicing machine(PAGE 59)



V-997D-4/KS-FR01
Cylinder bed overlock, with pneumatic
cloth expanding device(PAGE 19)

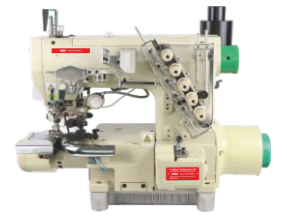

V-888A-33ABx364/UT
TaiWan design auto trimmer
cylinder bed interlock for elastic with
right side knife and pulley(PAGE 25)



V-JD00B
Automatic bra shoulder strap
machine

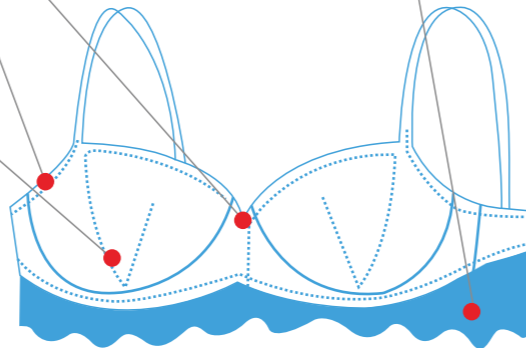

V-BK1700-22
Automatic bra buckle sewing
machine

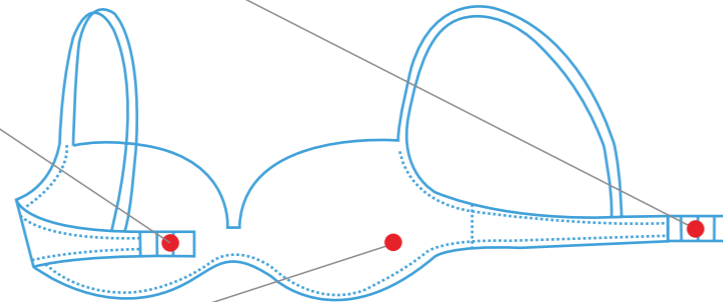

V-A1-C
Automatic bra cup
Die-cutting machine

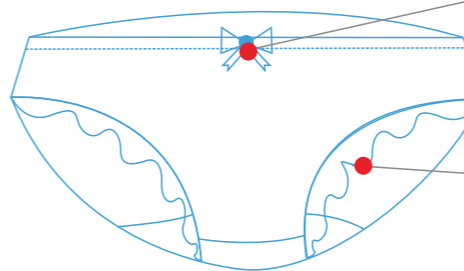
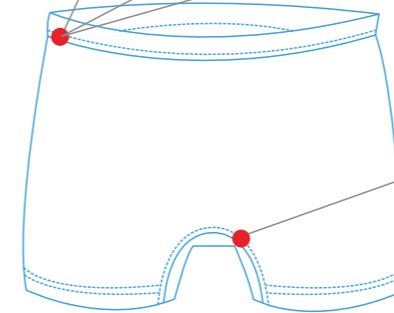

V-701
Flat-seamer 4 needle 6
Thread machine(PAGE 21)



V-BOW-AT
bow machine



V-TC60-2
Ultrasonic machine with double motor,
with air cylinder, inner side roller
(PAGE 147)